

TASCAM

D01306320A

SS-R250N

SOLID STATE RECORDER

OWNER'S MANUAL



IMPORTANT SAFETY PRECAUTIONS



CAUTION
RISK OF ELECTRIC SHOCK
DO NOT OPEN



CAUTION: TO REDUCE THE RISK OF ELECTRIC SHOCK, DO NOT REMOVE COVER (OR BACK). NO USER-SERVICEABLE PARTS INSIDE. REFER SERVICING TO QUALIFIED SERVICE PERSONNEL.



The lightning flash with arrowhead symbol, within equilateral triangle, is intended to alert the user to the presence of uninsulated "dangerous voltage" within the product's enclosure that may be of sufficient magnitude to constitute a risk of electric shock to persons.



The exclamation point within an equilateral triangle is intended to alert the user to the presence of important operating and maintenance (servicing) instructions in the literature accompanying the appliance.

WARNING: TO PREVENT FIRE OR SHOCK HAZARD, DO NOT EXPOSE THIS APPLIANCE TO RAIN OR MOISTURE.

IN USA/CANADA, USE ONLY ON 120 V SUPPLY.

For Canada

THIS CLASS B DIGITAL APPARATUS COMPLIES WITH CANADIAN ICES-003.

CET APPAREIL NUMERIQUE DE LA CLASSE B EST CONFORME A LA NORME NMB-003 DU CANADA.

For U.S.A.

Declaration of Conformity

Model Number: SS-R250N

Trade Name: TASCAM

Responsible party: TEAC AMERICA, INC.

Address: 1834 Gage Road, Montebello, California, U.S.A.

Telephone number: 1-323-726-0303

This device complies with Part 15 of the FCC Rules. Operation is subject to the following two conditions: (1) this device may not cause harmful interference, and (2) this device must accept any interference received, including interference that may cause undesired operation.

INFORMATION TO THE USER

This equipment has been tested and found to comply with the limits for a Class B digital device, pursuant to Part 15 of the FCC Rules. These limits are designed to provide reasonable protection against harmful interference in a residential installation. This equipment generates, uses, and can radiate radio frequency energy and, if not installed and used in accordance with the instruction manual, may cause harmful interference to radio communications. However, there is no guarantee that interference will not occur in a particular installation. If this equipment does cause harmful interference to radio or television reception, which can be determined by turning the equipment off and on, the user is encouraged to try to correct the interference by one or more of the following measures.

- Reorient or relocate the receiving antenna.
- Increase the separation between the equipment and receiver.
- Connect the equipment into an outlet on a circuit different from that to which the receiver is connected.
- Consult the dealer or an experienced radio/TV technician for help.

CAUTION

Changes or modifications to this equipment not expressly approved by TEAC CORPORATION for compliance could void the user's authority to operate this equipment.



This product complies with the European Directives request and the other Commission Regulations.

CE Marking Information

EN55103-2

- Applicable electromagnetic environment: E1, E2, E3, E4
- The average half-cycle r.m.s. inrush current
 - On initial switch-on: 2.91 Arms
 - After a supply interruption of 5s: 0.15 Arms

IMPORTANT SAFETY INSTRUCTIONS

- 1 Read these instructions.
- 2 Keep these instructions.
- 3 Heed all warnings.
- 4 Follow all instructions.
- 5 Do not use this apparatus near water.
- 6 Clean only with dry cloth.
- 7 Do not block any ventilation openings. Install in accordance with the manufacturer's instructions.
- 8 Do not install near any heat sources such as radiators, heat registers, stoves, or other apparatus (including amplifiers) that produce heat.
- 9 Do not defeat the safety purpose of the polarized or grounding-type plug. A polarized plug has two blades with one wider than the other. A grounding type plug has two blades and a third grounding prong. The wide blade or the third prong are provided for your safety. If the provided plug does not fit into your outlet, consult an electrician for replacement of the obsolete outlet.
- 10 Protect the power cord from being walked on or pinched particularly at plugs, convenience receptacles, and the point where they exit from the apparatus.
- 11 Only use attachments/accessories specified by the manufacturer.
- 12 Use only with the cart, stand, tripod, bracket, or table specified by the manufacturer, or sold with the apparatus. When a cart is used, use caution when moving the cart/apparatus combination to avoid injury from tip-over.



- 13 Unplug this apparatus during lightning storms or when unused for long periods of time.
- 14 Refer all servicing to qualified service personnel. Servicing is required when the apparatus has been damaged in any way, such as power-supply cord or plug is damaged, liquid has been spilled or objects have fallen into the apparatus, the apparatus has been exposed to rain or moisture, does not operate normally, or has been dropped.

- The apparatus draws nominal non-operating power from the AC outlet with its POWER or STANDBY/ON switch not in the ON position.
- The mains plug is used as the disconnect device, the disconnect device shall remain readily operable.
- Caution should be taken when using earphones or headphones with the product because excessive sound pressure (volume) from earphones or headphones can cause hearing loss.
- If you are experiencing problems with this product, contact TEAC for a service referral. Do not use the product until it has been repaired.

CAUTION

- Do not expose this apparatus to drips or splashes.
- Do not place any objects filled with liquids, such as vases, on the apparatus.
- Do not install this apparatus in a confined space such as a book case or similar unit.
- The apparatus should be located close enough to the AC outlet so that you can easily grasp the power cord plug at any time.
- If the product uses batteries (including a battery pack or installed batteries), they should not be exposed to sunshine, fire or excessive heat.
- CAUTION for products that use replaceable lithium batteries: there is danger of explosion if a battery is replaced with an incorrect type of battery. Replace only with the same or equivalent type.

WARNING

- Products with Class I construction are equipped with a power supply cord that has a grounding plug. The cord of such a product must be plugged into an AC outlet that has a protective grounding connection.

■ RACK-MOUNTING THE UNIT

Use the supplied rack-mounting kit to mount the unit in a standard 19-inch rack, as shown below.

Remove the feet of the unit before mounting.

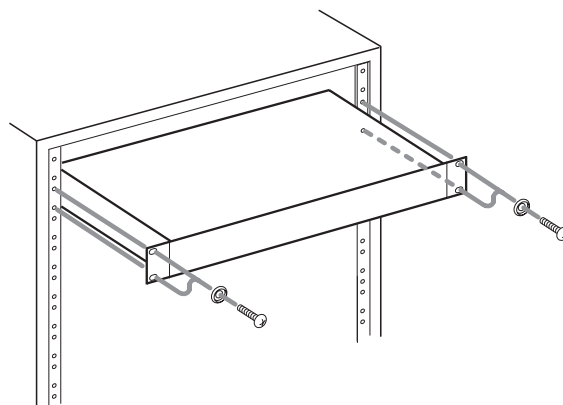

CAUTION

- Leave 1U of space above the unit for ventilation.
- Allow at least 10 cm (4 in) at the rear of the unit for ventilation.

Safety Information

CAUTIONS ABOUT BATTERIES

This product uses batteries. Misuse of batteries could cause a leak, rupture or other trouble. Always abide by the following precautions when using batteries.

- Never recharge non-rechargeable batteries. The batteries could rupture or leak, causing fire or injury.
- When installing batteries, pay attention to the polarity indications (plus/minus (+/-) orientation), and install them correctly in the battery compartment as indicated. Putting them in backward could make the batteries rupture or leak, causing fire, injury or stains around them.
- When you store or dispose batteries, isolate their terminals with insulation tape or something like that to prevent them from contacting other batteries or metallic objects.
- When throwing used batteries away, follow the disposal instructions indicated on the batteries and the local disposal laws.
- Do not use batteries other than those specified. Do not mix and use new and old batteries or different types of batteries together. The batteries could rupture or leak, causing fire, injury or stains around them.
- Do not carry or store batteries together with small metal objects. The batteries could short, causing leak, rupture or other trouble.
- Do not heat or disassemble batteries. Do not put them in fire or water. Batteries could rupture or leak, causing fire, injury or stains around them.
- If the battery fluid leaks, wipe away any fluid on the battery case before inserting new batteries. If the battery fluid gets in an eye, it could cause loss of eyesight. If fluid does enter an eye, wash it out thoroughly with clean water without rubbing the eye and then consult a doctor immediately. If the fluid gets on a person's body or clothing, it could cause skin injuries or burns. If this should happen, wash it off with clean water and then consult a doctor immediately.
- The unit power should be off when you install and replace batteries.
- Remove the batteries if you do not plan to use the unit for a long time. Batteries could rupture or leak, causing fire, injury or stains around them. If the battery fluid leaks, wipe away any fluid on the battery compartment before inserting new batteries.
- Do not disassemble a battery. The acid inside the battery could harm skin or clothing.

WARNING

DO NOT INGEST BATTERY, CHEMICAL BURN HAZARD

followed by:

[The remote control supplied with] This product contains a coin/button cell battery. If the coin/button cell battery is swallowed, it can cause severe internal burns in just 2 hours and can lead to death.

Keep new and used batteries away from children. If the battery compartment does not close securely, stop using the product and keep it away from children.

If you think batteries might have been swallowed or placed inside any part of the body, seek immediate medical attention.

■ For European Customers

Disposal of electrical and electronic equipment

- (a) All electrical and electronic equipment should be disposed of separately from the municipal waste stream via designated collection facilities appointed by the government or the local authorities.
- (b) By disposing of the electrical and electronic equipment correctly, you will help save valuable resources and prevent any potential negative effects on human health and the environment.
- (c) Improper disposal of waste equipment can have serious effects on the environment and human health as a result of the presence of hazardous substances in electrical and electronic equipment.
- (d) The crossed out wheeled dust bin symbol indicates that electrical and electronic equipment must be collected and disposed of separately from household waste.



- (e) The return and collection systems are available to the end users. For more detailed information about disposal of old electrical and electronic equipment, please contact your city office, waste disposal service or the shop where you purchased the equipment.

Disposal of batteries and/or accumulators

- (a) Waste batteries and/or accumulators should be disposed of separately from the municipal waste stream via designated collection facilities appointed by the government or the local authorities.
- (b) By disposing of waste batteries and/or accumulators correctly, you will help save valuable resources and prevent any potential negative effects on human health and the environment.
- (c) Improper disposal of waste batteries and/or accumulators can have serious effects on the environment and human health as a result of the presence of hazardous substances in batteries and/or accumulators.
- (d) The crossed out wheeled dust bin symbol indicates that batteries and/or accumulators must be collected and disposed of separately from household waste.

If the battery or accumulator contains more than the specified values of lead (Pb), mercury (Hg), and/or cadmium (Cd) defined in the Battery Directive (2006/66/EC), then the chemical symbols for lead (Pb), mercury (Hg) and/or cadmium (Cd) will be indicated beneath the crossed out wheeled dust bin symbol.



Pb, Hg, Cd

- (e) The return and collection systems are available to the end users. For more detailed information about disposal of waste batteries and/or accumulators, please contact your city office, waste disposal service or the shop where you purchased them.

■ For China



“仅适用于海拔 2000m 以下地区安全使用”



“仅适用于非热带气候条件下安全使用”



“环境保护使用年限”

产品有毒有害物质或元素的名称及含量

机种：SS-R250N		有毒有害物质或元素					
	品名	铅 (Pb)	汞 (Hg)	镉 (Cd)	六价铬 (Cr6+)	多溴联苯 (PBB)	多溴二苯醚 (PBDE)
1	CHASSIS 部份	○	○	○	○	○	○
2	FRONT PANEL 部份	○	○	○	○	○	○
3	螺丝部份	○	○	○	○	○	○
4	线材部份	○	○	○	○	○	○
5	PCB Assy 部份	×	○	○	○	○	○
6	电源部份	○	○	○	○	○	○
7	附属品部份	×	○	○	○	○	○
8	LABEL 部份	○	○	○	○	○	○
9	包装部份	○	○	○	○	○	○

○：表示该有毒有害物质在该部件所有均质材料中的含量均在 GB/T26572 标准规定的限量要求以下。

×：表示该有毒有害物质至少在该部件的某一均质材料中的含量超出 GB/T26572 标准规定的限量要求。

(针对现在代替技术困难的电子部品及合金中的铅)

Contents

1 – Introduction	9	Playing tracks.....	31
Features.....	9	Selecting tracks for playback.....	31
Items included with this product.....	9	Skipping to earlier and later tracks.....	31
Conventions used in this manual.....	9	Selecting tracks directly.....	31
Trademarks.....	10	Searching backward and forward.....	32
Precautions for placement and use.....	10	Jog playback.....	32
Notes about power supplies.....	10	Program playback.....	32
Beware of condensation	10	Setting the program.....	32
Cleaning the unit	10	Using the pitch control function.....	33
SD cards and USB flash drives	11	Using the key control function	33
Precautions for use	11	Using the repeat playback function.....	34
SD card write protection.....	11	Ordinary repeat playback settings.....	34
Note about formatting.....	11	A-B repeat playback settings	34
Using the TEAC Global Site.....	11	Using the auto cue function	34
User registration.....	11	Using the auto ready function.....	35
2 – Names and Functions of Parts	12	Using the incremental playback function.....	35
Front panel.....	12	Playing back in mono.....	35
Rear panel.....	14	Using the ducking function	36
PARALLEL connector overview	15	Using the EOM function.....	36
Wireless remote control (TASCAM RC-10).....	16	Setting the EOM tally output trigger	36
Home Screen	16	Using this function	36
Recording Screen.....	18	Using the resume function.....	37
Menu structure	19	Using the time skip function	37
Basic Menu Screen operations.....	21	Setting playback start timing	38
Menu operation procedures	22	Setting the sampling rate of output audio.....	38
3 – Preparation.....	23	Using the call function.....	38
Making connections	23	Setting the call function	38
Preparing the remote control.....	24	Using the link playback function	39
Installing the coin battery	24	Making connections for link playback.....	39
When to replace the battery	24	Making link playback settings	39
Battery precautions	24	Using the flash start function	39
Using the wireless remote control	24	5 – Working with Folders and Files (BROWSE screen)	40
Installing a Dante interface card		Opening the BROWSE screen	40
(sold separately)	25	Navigating the BROWSE screen.....	40
Turning the unit on and off.....	25	Icons on the BROWSE screen.....	41
Setting the built-in clock date and time.....	26	Folder operations.....	41
Adjusting the display.....	26	File operations	42
Adjusting the display and indicator brightness.....	26	Editing folder and file names	42
Adjusting the display contrast	26	Deleting folders and files.....	43
Inserting and removing SD cards	27	Undoing folder or file deletion (UNDO).....	43
Inserting SD cards	27	Assigning files to a playlist	43
Removing SD cards.....	27	Creating new folders	44
Using the security screw.....	27	Copying folders and files	44
SD card write-protection switches.....	27	Moving folders and files.....	45
Connecting and disconnecting USB flash drives	28	6 – Editing Playlists.....	46
Selecting media.....	28	Playlist editing overview	46
Preparing SD cards and USB flash drives for use	28	Opening the playlist screen	46
Setting the lock function	29	Opening the playlist screen from the BROWSE screen.....	46
Opening the INFORMATION screen	29	Opening the current playlist screen from the menu page..	46
4 – Playback	30	Assigning files to a playlist	46
Files that can be played back	30	Playlist menu operations	47
Tracks and files	30	Setting the current playlist.....	47
Playback area.....	30	Editing playlist names	48
Setting the playback area.....	30	Saving the current playlist with a different name	48
Selecting the current folder or current playlist	30	Deleting playlists.....	48
Setting the play mode	31	Creating new playlists	49
Basic playback operations	31	Playlist entry menu operations.....	49

Assigning files to playlists	50
Clearing file assignments from playlists	50
RC-SS150 MODE playlist assignment screen	51
7 – Recording	52
Unexpected power interruptions	52
Selecting the input source	52
Input source display.....	53
Setting left/right channel inputs separately.....	53
Setting mic/line input sensitivity.....	54
Adjusting input signal levels	54
Setting phantom power.....	55
Setting automatic gain control for mic inputs.....	55
Using the dynamics function	56
Setting the low-cut filter.....	56
Setting the recording file format.....	57
Making recording format settings	57
Setting the second medium for backup and relay recording ..	57
WAV file settings.....	58
MP3 file bit rate setting.....	58
Recording input channel settings.....	58
Monitoring input signals.....	58
Basic recording operations.....	58
Setting the file name format.....	59
Editing text	59
Applying dithering to recording.....	60
Using the sampling rate converter.....	60
Setting the pause mode.....	60
Skipping recording standby before recording (direct recording) ..	60
Recording a few seconds in advance (pre-recording).....	61
Using the synchronized recording function	61
Synchronized recording settings.....	61
Sync recording operation overview	61
Incrementing track numbers during recording.....	62
Incrementing track numbers manually.....	62
Incrementing track numbers automatically.....	62
Adding marks manually when recording	63
Adding marks when recording.....	63
Adding marks automatically when recording.....	64
Recording duration	65
8 – Using the Edit Menu.....	66
Edit menu operations.....	66
Deleting tracks (DELETE).....	66
Dividing tracks (DIVIDE).....	67
Combining tracks (COMBINE).....	68
Undoing edit menu operations (UNDO)	68
9 – Timer Event Function.....	69
Turning the timer event function on/off.....	69
Opening the timer event list screen	69
Timer event bliss menu operations.....	70
Editing timer events.....	70
Setting the event type.....	71
Setting the playback area.....	71
Selecting files/folders for playback by inputting path names ..	71
Selecting the input to use when recording.....	72
Setting folders/files to use for FTP server download	72
Selecting files/folders for download by inputting path names... 72	
Setting execution schedules for timer events	72
Setting days for timer event execution	73
Setting dates for timer event execution	73
Setting times for timer event execution	73
Setting what happens at the time set for the playback timer event.. 73	
Setting the frequency intervals of events that repeat.....	73
Setting the number of event repetitions.....	74
Creating new timer events	74
Deleting timer events.....	74
Deleting all timer events.....	74
10 – Mark and Locate Functions.....	75
Mark function.....	75
Adding marks	75
Using marks.....	75
Moving to marks.....	75
Editing mark names	76
Deleting marks.....	76
Deleting all marks in the current file.....	76
Editing mark locations.....	76
Viewing mark information	76
Locating to a specific time.....	77
Locating before completely specifying the time.....	77
11 – Network Functions	78
Network function settings.....	78
FTP client function settings	79
Selecting folders to use by inputting path names.....	80
FTP server functions	80
Remote control.....	81
Setting the SNTP function	82
12 – Other Settings, Information Screens and Keyboard Operations	84
Power on action function setting	84
Adjusting the analog output.....	84
Setting the reference level	84
Using a USB keyboard to operate the unit	84
Setting the keyboard type	84
Using the keyboard to input names and values	85
List of keyboard operations.....	85
Viewing media information	87
Restoring factory default settings	87
Saving and loading user settings.....	87
Saving user settings	87
Loading user settings	87
Exporting/importing system backup data	88
Checking the firmware version.....	89
Firmware update procedures	89
13– Using the Remote Control Connectors	90
Using the RS-232C connector	90
Using a footswitch (TASCAM RC-3F)	90
Setting up the footswitch	90
Using the footswitch.....	90
14 – Messages	91
15 – Troubleshooting	94
16 – Specifications.....	95
General	95
Input and output	95
Analog audio input and output ratings.....	95

Contents

Digital audio input/output ratings	95
Control input/output	96
Audio performance.....	96
Other	96
Dimensional drawings.....	97
Block diagrams	98

1 – Introduction

Thank you very much for purchasing the TASCAM SS-R250N Solid State Recorder.

Before using this unit, read this Owner's Manual carefully so that you will be able to use it correctly and enjoy working with it for many years. After you have finished reading this manual, please keep it in a safe place for future reference.

You can also download this Owner's Manual from the TEAC Global Site (<http://teac-global.com/>).

Features

- FTP client/server functions enable the uploading and downloading of recording/playback files
- Event list functions allow recording, playback, downloading and other operations to be conducted automatically at set times
- Time synchronization using the SNTP client function enables even more accurate event execution
- Automatic uploading function for recording data
- Control applications for iOS and Android enable remote control of the transport, browsing and various settings
- SD cards (including SDXC cards up to 128 GB) and USB flash drives supported
- Dual slots for SD cards enable backup recording and relay recording
- Dual format recording allows simultaneous recording of both WAV and MP3 files
- Automatic file closing process prevents the loss of recorded data even during sudden power outages
- Link playback function enables simultaneous operation of two units
- Built-in inputs and outputs include analog XLR and RCA and digital AES/EBU and S/PDIF
- Mic input supported and phantom power can be supplied
- RS-232C serial and 25-pin D-sub parallel connectors built-in
- IF-DA2 interface card for two-channel Dante input and output can be installed (sold separately)
- TASCAM RC-SS150 flash start remote control unit supported (sold separately)
- As the successor model to the SS-R200 and SS-CDR200, this unit includes their diverse playback and recording functions

Items included with this product

This product includes the following items.

Take care when opening the package to avoid damaging the items. Keep the packing materials for transportation in the future.

Please contact the store where you purchased this unit if any of these items are missing or have been damaged during transportation.

- Main unit× 1
- Power cord.....× 1
- Wireless remote control (TASCAM RC-10)× 1
- Lithium coin battery (CR2025) for remote control (already installed)× 1
- Rackmount screw kit.....× 1
- Security screw kit× 1
- Owner's Manual (this document) including warranty× 1

Conventions used in this manual

In this manual, we use the following conventions:

- When we refer to buttons, connectors and other parts of this unit, we use a bold font like this: **MENU [JOG]** button.
- When we show characters that appear on the display, the typeface looks like this: **PLAY AREA**.
- "SD card" indicates SD, SDHC and SDXC memory cards.
- "USB flash drives" are sometimes called "USB drives".
- The medium that is currently selected is called the "current medium".
- The folder that is currently selected is called the "current folder".
- The playlist that is currently selected is called the "current playlist".
- As necessary, additional information is provided under TIP, NOTE and CAUTION headings.

TIP

These are tips about how to use the unit.

NOTE

These provide additional explanations and describe special cases.

CAUTION

Failure to follow these instructions could result in injury, damage to equipment or lost recording data, for example.

1 – Introduction

Trademarks

- TASCAM is a registered trademark of TEAC Corporation.
- SDXC Logo is a trademark of SD-3C, LLC.



- MPEG Layer-3 audio coding technology licensed from Fraunhofer IIS and Thomson.
- Supply of this product does not convey a license nor imply any right to distribute MPEG Layer-3 compliant content created with this product in revenue-generating broadcast systems (terrestrial, satellite, cable and/or other distribution channels), streaming applications (via Internet, intranets and/or other networks), other content distribution systems (pay-audio or audio-on-demand applications and the like) or on physical media (compact discs, digital versatile discs, semiconductor chips, hard drives, memory cards and the like). An independent license for such use is required. For details, please visit <http://mp3licensing.com>.
- Other company names, product names and logos in this document are the trademarks or registered trademarks of their respective owners.

Information is given about products in this manual only for the purpose of example and does not indicate any guarantees against infringements of third-party intellectual property rights and other rights related to them. TEAC Corporation will bear no responsibility for infringements on third-party intellectual property rights or their occurrence because of the use of these products.

With the exception of personal enjoyment and similar uses, copyrighted materials belonging to third parties cannot be used without permission from the rights holders in accordance with copyright law. Please use the equipment appropriately. TEAC Corporation will bear no responsibility for rights infringements committed by users of this product.

Precautions for placement and use

- The operating temperature range of this unit is 5–35 °C.
- Do not install this unit in the following types of locations. Doing so could make the sound quality worse or cause malfunction.
 - Locations with frequent vibrations
 - Near windows or other places exposed to direct sunlight
 - Near heaters or other extremely hot places
 - Extremely cold places
 - Very humid or poorly ventilated places
 - Very dusty places
- To enable good heat dissipation, do not place anything on top of the unit.
- Do not place the unit on top of a power amplifier or other device that generates heat.
- To mount this unit in a rack, use the included rackmount screw kit and mount it as shown in the illustration below. Leave at least 1U of space open above it in the rack.

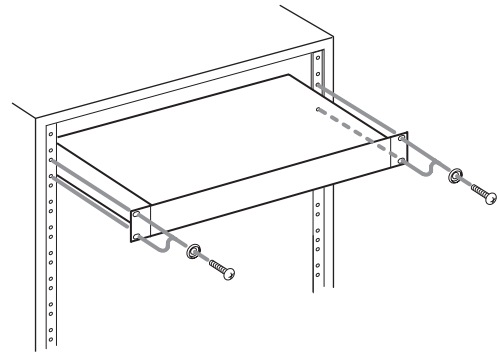

Notes about power supplies

- Insert the included power cord all the way into the AC IN connector.
- Do not connect a power supply other than one that is AC100V (50-60Hz).
- Hold the power cord by its plug when connecting or disconnecting it.

Beware of condensation

Condensation could occur if the unit is moved from a cold place to a warm place, it is used immediately after a cold room has been heated or it is otherwise exposed to a sudden temperature change. To prevent this, or if this occurs, let the unit sit for one or two hours at the new room temperature before using it.

Cleaning the unit

Use a dry soft cloth to wipe the unit clean. Do not wipe with chemical cleaning cloths, thinner, alcohol or other chemical agents. Doing so could damage the surface or cause discoloration.

SD cards and USB flash drives

This unit uses SD cards and USB flash drives for recording and playback.

A list of SD cards and USB flash drives that have been confirmed for use with this unit can be found on our web site. Please access to a product page of this product from the TEAC Global Site (<http://teac-global.com>) to find the list or contact the TASCAM customer support service.

Precautions for use

SD cards and USB flash drives are delicate media. In order to avoid damaging SD cards and USB flash drives, please take the following precautions when handling them.

- Do not leave them in extremely hot or cold places.
- Do not leave them in extremely humid places.
- Do not let them get wet.
- Do not put things on top of them or twist them.
- Do not hit them.
- Do not remove or insert them during recording, playback, data transmission or other access.
- When transporting them, put them into cases, for example.

SD card write protection

This unit writes track information to the media in order to improve operation performance. Since track information cannot be written to SD cards that are write-protected, the amount of time needed to read media will become longer, for example.

Note about formatting

SD cards and USB flash drives formatted by this unit are optimized to improve performance during recording. Use this unit to format the SD cards and USB flash drives to be used with it. Errors might occur when recording with this unit using an SD card or USB flash drive formatted by a computer or other device.

Using the TEAC Global Site

You can download the Owner's Manual necessary for this unit from the TEAC Global Site (<http://teac-global.com/>).

1. Open the TEAC Global Site (<http://teac-global.com/>).
2. In the TASCAM Downloads section, click the desired language to open the Downloads website page for that language.

NOTE

If the desired language does not appear, click Other Languages.

3. Click the product name in the "Search by Model Name" section to open the Downloads page for that product.
4. Select and download the Owner's Manual that are needed.

User registration

Customers in the USA, please visit the TASCAM website (<http://tascam.com/>) to register as a user online.

2 – Names and Functions of Parts

Front panel

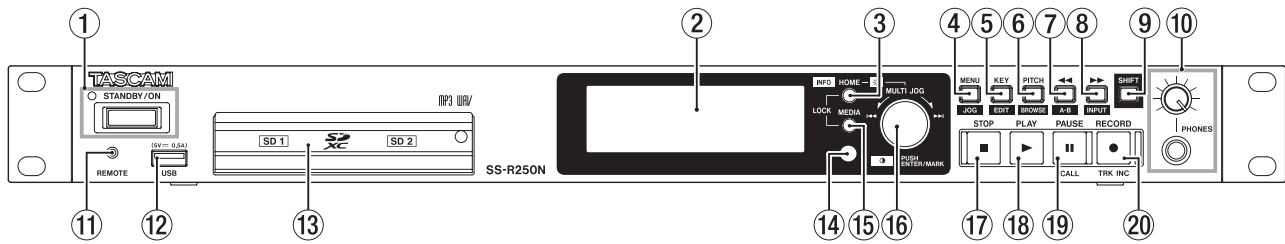

① STANDBY/ON button and indicator

Press this button to turn the unit on and off (standby).
The **STANDBY/ON** indicator lights when the unit is off.

CAUTION

*Before turning the unit on, lower the volumes of connected equipment to their minimum levels.
Failure to do so could result in a sudden loud noise that could harm hearing, for example.*

② Display

This shows a variety of information.

③ HOME [INFO] button

- When a Menu or **BROWSE** screen is open, press this button to return to the Home Screen.
- When the Home Screen is open, press this button to change the Home Screen display mode. (see “Home Screen” on page 16), (see “Recording Screen” on page 18)

→ TRACK → TOTAL → TITLE → FOLDER →

- Press this button and the **MEDIA** button at the same time to open the **LOCK SETUP** screen. (see “Setting the lock function” on page 29)
- Press this button while pressing the **SHIFT** button to show the operation status of the unit. (see “Opening the INFORMATION screen” on page 29)

④ MENU [JOG] button

- When the Home Screen is open, press this button to open the Menu Screen. (see “Menu structure” on page 19), (see “Basic Menu Screen operations” on page 21)
- When the Menu Screen is open, press this button to change the menu page.
- When the Menu Screen is open, press this button while pressing the **SHIFT** button to change the menu page in reverse direction.
- When a sub menu screen is open, press this button to go back one step in the menu.
- Press this button while pressing the **SHIFT** button when playing back, in playback standby or stopped on the Home Screen to enable jog playback mode. (see “Jog playback” on page 32)
- Press this button when a pop-up message is open to close it.

⑤ KEY [EDIT] button

- When the Home Screen is open, press this button to open the key control setting pop-up window. (see “Using the key control function” on page 33)
When this pop-up is open, press the **MULTI JOG** dial to turn the key control function on/off.
When this pop-up is open, turn the **MULTI JOG** dial to change the key.
- Press this button while pressing the **SHIFT** button to open the edit menu pop-up. (see “Edit menu operations” on page 66)

⑥ PITCH [BROWSE] button

- When the Home Screen is open, press this button to open the pitch control setting pop-up window. (see “Using the pitch control function” on page 33)
When this pop-up is open, press the **MULTI JOG** dial to turn the pitch control function on/off.
When this pop-up is open, turn the **MULTI JOG** dial to change the pitch in 1% increments.
- When this pop-up is open, press and turn the **MULTI JOG** dial to change the pitch in 0.1% increments.
- Press this button while pressing the **SHIFT** button when playing back, in playback standby or stopped to open the **BROWSE** screen.

⑦ [A-B] button

- When playing back or in playback standby, press to skip by the amount of time set with the time skip function. (see “Using the time skip function” on page 37)
- When playing back or in playback standby, press and hold this button to search backward while outputting audio (review).
- When stopped and the playback area is set to **FOLDER**, press to switch the current folder.
- When stopped and the playback area is set to **PLAYLIST**, press to switch the current playlist.
- When the **BROWSE** screen is open, press this button to go up one level. (see “Navigating the BROWSE screen” on page 40)
- When the Home Screen is open, press this button while pressing the **SHIFT** button to turn the A-B repeat playback function on. (see “A-B repeat playback settings” on page 34)

2 – Names and Functions of Parts

⑧ ►► [INPUT] button

- When playing back or in playback standby, press to skip by the amount of time set with the time skip function.(see “Using the time skip function” on page 37)
- When playing back or in playback standby, press and hold this button to search forward while outputting audio (cue).
- When stopped and the playback area is set to **FOLDER**, press to switch the current folder.
- When stopped and the playback area is set to **PLAYLIST**, press to select the current playlist.
- When the **BROWSE** screen is open and a folder is selected, press this button to show the contents of that folder. (see “Navigating the BROWSE screen” on page 40)
- Press this button while pressing the **SHIFT** button to open the input source setting pop-up window. When the input source setting window is open, turn the **MULTI JOG** dial to select the input source. After selection press the **MULTI JOG** dial to change the input source.(see “Selecting the input source” on page 52)

⑨ **SHIFT** button

- While pressing this button, press a button with a blue label to use that function.
- When the Home Screen is open, press this button to scroll file and folder names.
- When the **BROWSE** Screen is open, press this button to scroll file and folder names that are not shown completely.
- While pressing this button, turn the **MULTI JOG** dial to adjust the contrast of the display.

⑩ **PHONES** jack and knob

Use this standard stereo jack to connect stereo headphones. Use an adapter to connect headphones with a mini plug. Use the **PHONES** knob to adjust the headphone output level.

CAUTION

*Before connecting headphones, minimize the volume with the **PHONES** knob. Failure to do so could result in a sudden loud noise that could harm hearing, for example.*

⑪ **REMOTE** jack (2.5mm TRS)

Connect a TASCAM RC-3F footswitch or TASCAM RC-20 direct play remote control (both sold separately) here. This enables remote starting and stopping of playback and other functions.

When a TASCAM RC-3F footswitch is connected, you can change the functions of the three pedals.(see “Using a footswitch (TASCAM RC-3F)” on page 90)

⑫ **USB** port

Connect (and disconnect) USB flash drives here.(see “Connecting and disconnecting USB flash drives” on page 28)

When a USB flash drive is connected, files on it can be played back and files can be recorded to it. In addition, you can also connect a USB keyboard here and use it to input folder and file names, for example, as well as for external control.

By default, the unit is set to use a Japanese (JIS) keyboard. Since English and Japanese (JIS) keyboards use different layouts, change the setting on the **KEYBOARD TYPE** screen if you are using an English keyboard.(see “Setting the keyboard type” on page 84)

⑬ **SD** card slots

Insert SD cards in these slots.(see “Inserting and removing SD cards” on page 27)

⑭ **Remote control** signal receiver

Signals from the remote control (TASCAM RC-10) are received here. When operating the remote control, point it toward this receiver.

⑮ **MEDIA** button

- When the Home Screen is displayed, press this button to open the **MEDIA SELECT** Screen.(see “Selecting media” on page 28)
- Press this button and the **HOME [INFO]** button at the same time to open the **LOCK SETUP** screen.(see “Setting the lock function” on page 29)

⑯ **MULTI JOG** dial

This dial functions as a dial when turned and as a button when pressed.

Dial functions

- When the home screen is open during playback or playback standby and marks have been added, turn the **MULTI JOG** dial to move to marks. When there are no marks, turn to skip between tracks.
- When inputting a program, use to select tracks to assign.
- When a Menu Screen is open, turn to select items and change setting values.
- When editing names, use to select characters.
- During jog playback, use to move in 10msec intervals.(see “Jog playback” on page 32)
- While pressing the **SHIFT** button, turn the **MULTI JOG** dial to adjust the contrast of the display.
- While pressing the **HOME [INFO]** button, turn the **MULTI JOG** dial to adjust the brightness of the display and the various indicators.
- When the **BROWSE** screen is open, turn to select folders and files within the same folder.(see “Navigating the BROWSE screen” on page 40)

Button functions

- When the Home Screen is open and the unit is stopped, recording, in recording standby, playing back or in playback standby, press this button to add a mark.(see “Adding marks manually when recording” on page 63),(see “Adding marks” on page 75)
- When a Menu Screen is open, press to confirm selections and settings (ENTER button function).
- When the **BROWSE** screen is open, press this to show the pop-up folder/file menu for the selected folder/file.(see “Folder operations” on page 41),(see “File operations” on page 42)

⑰ **STOP** button

- Press to stop playback or recording.
- When the playback area is set to **PROGRAM** and playback is stopped, press to clear the entire program.

⑱ **PLAY** button and indicator

- Press when stopped or in playback standby to start playback.
- Press when in recording standby to start recording.
- This button lights during playback and recording.
- This button blinks during jog playback.

2 – Names and Functions of Parts

19 PAUSE [CALL] button and indicator

- Press when stopped or playing back to start playback standby.
- Press when recording to start recording standby.
- This button lights when in playback standby or recording standby.
- This button blinks during jog playback.
- When in playback standby, press this button to search for the call point (last point playback started from playback standby) and resume playback standby.(see “Using the call function” on page 38)

20 RECORD [TRK INC] button and indicator

- Press when stopped to start recording standby.
- When recording, press to divide the recording by creating a new file (increment the track number).
- This button lights when recording or in recording standby.
- If the currently-selected medium is not loaded, pressing this button starts input monitoring and the selected input signal will be output. This button blinks during input monitoring.

Rear panel

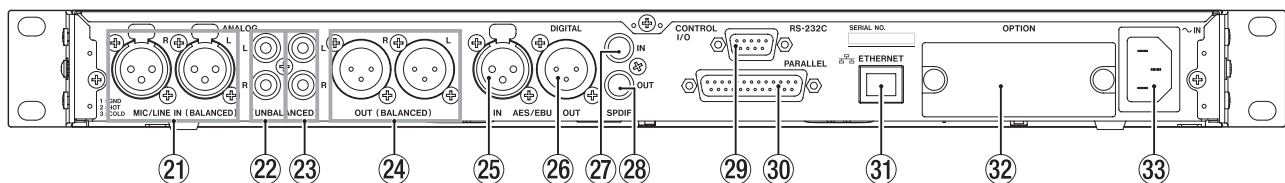

21 MIC/LINE IN (BALANCED) L/R jacks

These are balanced XLR analog input jacks.

- The nominal input level can be set to either +4 dBu (default) or +6 dBu. (1: GND, 2: HOT, 3: COLD),(see “Setting the reference level” on page 84)
- By changing the input sensitivity, you can use these as mic inputs.
(see “Setting mic/line input sensitivity” on page 54)

22 ANALOG IN (UNBALANCED) L/R jacks

These are analog RCA pin input jacks.
The nominal input level is -10 dBV.

23 ANALOG OUT (UNBALANCED) L/R jacks

These are analog RCA pin output jacks.
The nominal output level is -10 dBV.

24 ANALOG OUT (BALANCED) L/R jacks

These are balanced XLR analog output jacks.
The nominal output level can be set to either +4 dBu (default) or +6 dBu. (1: GND, 2: HOT, 3: COLD) (see “Setting the reference level” on page 84)

25 AES/EBU IN jack

This is a balanced XLR AES3-2003/IEC60958-4 (AES/EBU) format digital audio input jack.

A sampling rate converter that supports 32–192 kHz is built-in.(see “Using the sampling rate converter” on page 60)

To link a second SS-R250N, connect the AES/EBU OUT jack on the other unit to this jack.(see “Making connections for link playback” on page 39)

26 AES/EBU OUT jack

This is a balanced XLR AES3-2003/IEC60958-4 (AES/EBU) format digital audio output jack.

To link a second SS-R250N, connect the AES/EBU IN jack on the other unit to this jack.(see “Making connections for link playback” on page 39)

27 SPDIF IN jack

This is a digital audio input jack.

A sampling rate converter that supports 32–192 kHz is built-in.(see “Using the sampling rate converter” on page 60)

To link a second SS-R250N, connect the **SPDIF OUT** jack on the other unit to this jack.(see “Making connections for link playback” on page 39)

28 SPDIF OUT jack

This is a digital audio output jack.

Signals can be output in IEC60958-3 (S/PDIF) format.

To link a second SS-R250N, connect the **SPDIF IN** jack on the other unit to this jack.(see “Making connections for link playback” on page 39)

29 RS-232C connector

This is a 9-pin D-sub RS-422 control input/output connector.
Connect a TASCAM RC-SS150 remote control or personal computer, for example, here.(see “Using the RS-232C connector” on page 90)

30 PARALLEL connector

This is a 25-pin D-sub parallel control input/output connector.
Connect a TASCAM RC-SS20 or other external controller here.

31 ETHERNET port

This is an Ethernet port. Use this to connect to a network, transfer files and control the unit externally.

32 OPTION slot

Use this slot to install an I/O card (sold separately).

33 AC IN connector

Plug the included power cord in here.

2 – Names and Functions of Parts

PARALLEL connector overview

The PARALLEL connector on the back allows external control of the unit. (A TASCAM RC-SS20 can also be connected.)

The pin assignments are as follows.

Pin No.	Function	IN/OUT
1	GND	–
2	PLAY/Flash 1	IN
3	STOP/Flash 2	IN
4	RECORD/Flash 3	IN
5	▶▶1 (Next)/Flash 4	IN
6	1◀◀ (Previous)/Flash 5	IN
7	Flash Load	IN
8	Fader Start	IN
9	Flash Tally	OUT
10	Ready Tally	OUT
11	Record Tally	OUT
12	Stop Tally	OUT
13	Play Tally	OUT
14	Remote Select*	IN
15	Ready/Flash 6	IN
16	Call/Flash 7	IN
17	Auto Cue/Flash 8	IN
18	Auto Ready/Flash 9	IN
19	Pitch/Flash 10	IN
20	Flash Page**	IN
21	EOM Tally	OUT
22	Device Select Tally 1***	OUT
23	Ducking Tally	OUT
24	Device Select Tally 2***	OUT
25	+5V	–

- IN: External command reception active low (usually 30 msec or more, 1 sec or more when recording MP3 files, functions when connected to GND)
- OUT: Transport status display signals by open collector (10Ω output impedance, 20V withstand voltage, 35mA maximum current)
- +5V: 50mA maximum supplied current

*Pin 14 (Remote Select)

When high, the first function is enabled when there are two functions separated by a / for the input pin in the above table (pins 2–6 and 15–19), and it can be used as an ordinary parallel controller.

When low, those input pins function as flash start keys.

**Pin 20 (Flash Page)

When pin 14 (Remote Select) is low, the pin 20 high/low status determines the assigned tracks as follows.

#14	#20	Flash start tracks
Low	High	1–10
Low	Low	11–20

In the following connection example, fader starts and stops control playback of this unit.

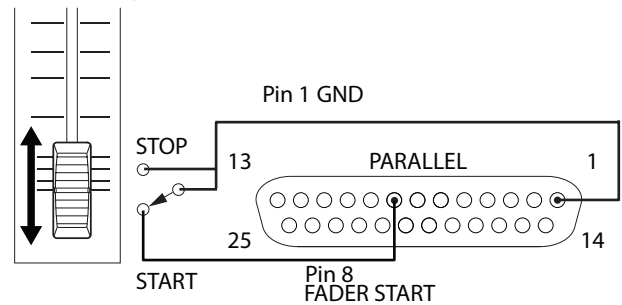

***Pin 22/Pin 24 (Device Select Tally 1/2)

The high/low statuses of pins 22 and 24 determine the device assignments as follows.

#22	#24	Device assignment
Low	Low	USB
High	High	SD1
High	Low	SD2

2 – Names and Functions of Parts

Wireless remote control (TASCAM RC-10)

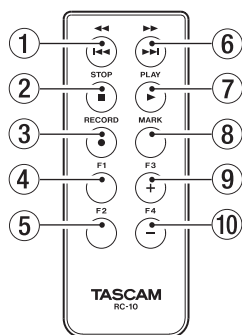

1 ◀◀/▶▶ button

Press briefly during playback to skip to the beginning of the track.
 Press briefly when near the beginning of a track to skip to the beginning of the track before it.
 Press and hold to search backwards.
 When the **BROWSE** screen is open, press to move up one level. (see “Navigating the BROWSE screen” on page 40)

2 ■ STOP button

Press to stop playback or recording.

3 ● RECORD button

Press when stopped to start recording standby.
 When recording, press to increment the track number (create a new file and continue recording). (see “Incrementing track numbers manually” on page 62)

4 F1 button

Press when stopped or playing back to start playback standby.
 Press when recording to start recording standby.

5 F2 button

When a Menu Screen is open, press this button to return to the Home Screen.
 Press when the Home Screen is open to change the display mode. (see “Home Screen” on page 16)

6 ▶▶/▶▶ button

Press briefly to skip to the beginning of the next track.
 Press and hold to search forward.
 When the **BROWSE** screen is open and a folder is selected, press this button to open that folder.

7 ▶▶▶▶ button

Press when stopped or playback ready to start playback.
 Press when in recording standby to start recording.

8 ■ MARK button

When stopped, recording, playing back or in playback standby, press this button to add a mark. (see “Adding marks manually when recording” on page 63) (see “Adding marks” on page 75)

9 F3 [+] button

Press to move to the next mark.
 When the **BROWSE** screen is open, press to move the cursor up. (see “Navigating the BROWSE screen” on page 40)

10 F4 [-] button

Press to move to the mark before the current location.
 When the **BROWSE** screen is open, press to move the cursor down. (see “Navigating the BROWSE screen” on page 40)

Home Screen

The Home Screen has four display modes: **TRACK**, **TOTAL**, **TITLE** and **FOLDER**.

Each time you press the **HOME [INFO]** button, the display mode will change.

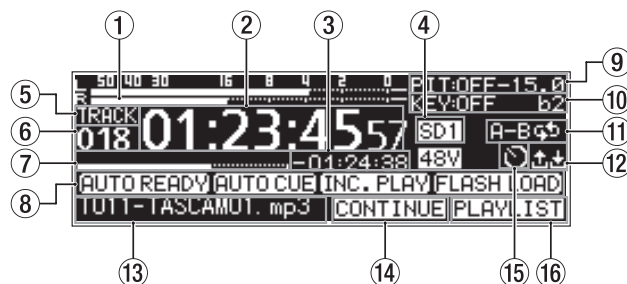

Home Screen **TRACK** display mode

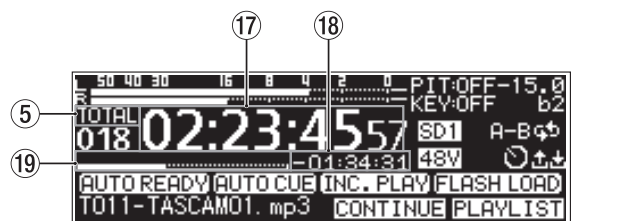

Home Screen **TOTAL** display mode

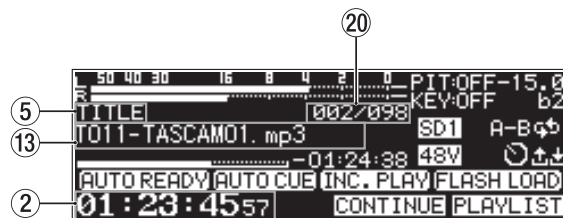

Home Screen **TITLE** display mode

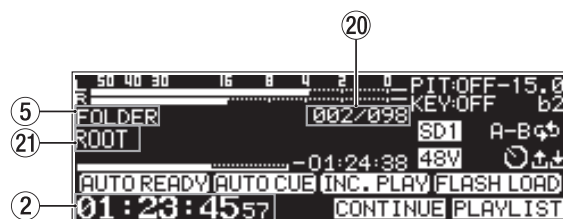

Home Screen **FOLDER** display mode

1 Level meters

This area shows the levels of the input and playback signals.

2 Elapsed time from track beginning

This shows the elapsed time from the beginning of the current track (hours: minutes: seconds).
 During jog playback 10msec intervals are also shown.

2 – Names and Functions of Parts

③ Remaining time to track end

This shows the remaining time to the end of the current track (hours: minutes: seconds).

④ Current medium

This shows the name of the currently selected medium.(see “Selecting media” on page 28)

: USB flash drive selected

: SD card 1 selected

: SD card 2 selected

⑤ Display mode

This shows the current Home Screen display mode.

⑥ Track number

This shows the number of the currently playing track.

⑦ Track playback position

This bar shows the current playback position.

As playback progresses, the bar extends from the left.

⑧ Playback function activation status

Icons appear for the playback functions that are currently on.

Icon	Meaning
	Appears when auto ready function is on
	Appears when auto cue function is on
	Appears when incremental playback function is on
	Appears when already flash loaded

⑨ Pitch control status

This shows whether the pitch control function is on/off and the currently set pitch adjustment.

⑩ Key control status

This shows whether the key control function is on/off and the currently set key adjustment.

⑪ Repeat playback status

An icon appears when the repeat playback function is on.

: Repeat playback

: A-B repeat playback

⑫ Upload/download status

An icon appears when files, for example, are being uploaded or downloaded via a network.

: Uploading

: Downloading

⑬ Track title

This shows the title of the current track.

Press the **SHIFT** button on the unit to scroll this.

⑭ Playback mode

This shows the current playback mode.(see “Setting the play mode” on page 31)

: Continuous playback mode

: Single playback mode

: Program playback mode

: Random playback mode

⑮ Timer event setting status

The icon appears when the timer event function is on.(see “Turning the timer event function on/off” on page 69)

⑯ Playback area

This shows the current playback file area.

: All files on the current medium

: All files in the selected folder

: All files assigned to the playlist

⑰ Total track elapsed time

This shows the elapsed time of the play area (hours: minutes: seconds).

⑱ Total track remaining time

This shows the remaining time of the play area (hours: minutes: seconds).

⑲ Total elapsed playback position

This bar shows the current playback position.

As playback progresses, the bar extends from the left.

⑳ Track number/total number of tracks

This shows the current track number and total number of tracks in the current playback area.

㉑ Folder name

This shows the name of the folder that contains the current track.

NOTE

- *When stopped, the total playback time of the playback area is always shown regardless of the Home Screen display mode setting.*
- *In PROGRAM mode, the elapsed time and remaining time are shown for the entire program rather than the entire playback area.*

2 – Names and Functions of Parts

Recording Screen

The Recording Screen has four display modes: TRACK, TOTAL, TITLE and FOLDER.

Each time you press the **HOME [INFO]** button, the display mode will change.

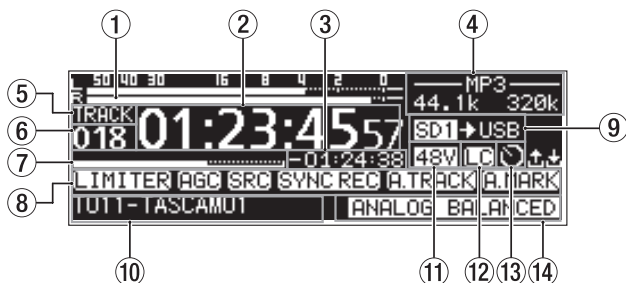

Recording Screen TRACK display mode

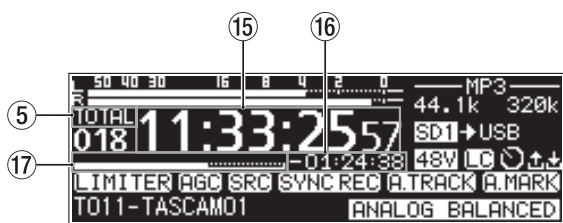

Recording Screen TOTAL display mode

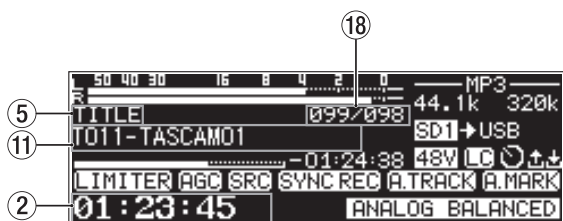

Recording Screen TITLE display mode

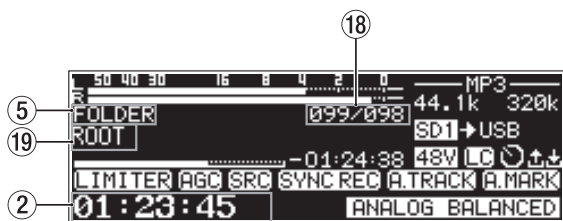

Recording Screen FOLDER display mode

① Input levels

The input sound levels are shown.

② Elapsed track recording time

This shows the elapsed time of the recorded file (hours: minutes: seconds).

③ Remaining track recording time

This shows the remaining time (hours: minutes: seconds) for the maximum file size (2 GB).

④ File type

This shows the current recording file format.

When dual format recording is on, two file formats are shown like **MP3/WAV**. (see "Making recording format settings" on page 57)

⑤ Display mode

This shows the current Home Screen display mode.

⑥ Track number

This shows the number of the track currently being recorded.

⑦ Track recording position

The current recording position is shown by a bar. As recording progresses, the bar extends from the left.

⑧ Recording function activation status

Icons appear for the recording functions that are currently on.

Icon	Meaning
LIMITER	Appears when the dynamics function LIMITER is on
COMP.SOFT	Appears when the dynamics function COMP_SOFT is on
COMP.HARD	Appears when the dynamics function COMP_HARD is on
AGC	Appears when the automatic gain control function is on
SRC	Appears when the sampling rate converter is on
SYNC REC	Appears when the sync recording function is on
A.TRACK	Appears when the automatic track incrementation function is on
A.MARK	Appears when the automatic mark function is on

⑨ Current medium

This shows the name of the currently selected medium.

When the relay recording function is on, an icon like **SD1 → SD2** will appear that shows the current medium and the next medium to be used for recording. (see "Making recording format settings" on page 57)

When the backup function is on, an icon like **SD1SD2** will appear that shows the two types of media used for recording. (see "Making recording format settings" on page 57)

⑩ Track title

This shows the title of the track being recorded.

⑪ Phantom power supply status

When phantom power is on, the **48V** icon appears. (see "Setting phantom power" on page 55)

⑫ Low-cut filter setting status

When the low-cut filter is set, the **LC** icon appears. (see "Setting the low-cut filter" on page 56)

⑬ Timer event setting status

The **☑** icon appears when the timer event function is on. (see "Turning the timer event function on/off" on page 69)

2 – Names and Functions of Parts

14 Input setting status

This shows the name of the currently selected input.

Icon	Meaning
	Input from ANALOG IN (UNBALANCED) L/R jacks
	Input from MIC/LINE IN (BALANCED) jacks
	Input from AES/EBU IN jack
	Input from SPDIF IN jack
	Input from IF-DA2 Dante interface card

15 Total track elapsed time

This shows the total recording time of everything on the current medium (hours: minutes: seconds).

16 Total track remaining time

This shows the remaining recording time available on the current medium (hours: minutes: seconds).

17 Total recording position

The current recording position is shown by a bar. As recording progresses, the bar extends from the left.

18 Track number/total number of tracks

This shows the current track number and total number of track in the current playback area.

19 Name of track recording folder

This shows the name of the folder where tracks are recorded.

NOTE

The remaining time differs according to the file recording format. (see "Setting the recording file format" on page 57)

Menu structure

Press the **MENU [JOG]** button to open the **PLAY 1** page of the menu.

The MENU screen has 21 pages organized by types of menu items.

	Page name	Contents
1	PLAY 1	
2	PLAY 2	Make playback settings.
3	PLAY 3	
4	PLAYLIST	
5	REC 1	Make recording settings.
6	REC 2	
7	REC 3	
8	REC 4	
9	REC 5	
10	TIMER EVENT	Make timer event settings.
11	MARK LIST	Make mark list settings.
12	NETWORK 1	Make network settings.
13	NETWORK 2	
14	FTP CLIENT	Make FTP settings.
15	SNTP	Make SNTP settings.
16	UTILITY	Make utility settings.
17	PREFERENCES	Make preference settings.
18	REMOTE	Make remote control settings.
19	MEDIA	Work with media.
20	SYSTEM 1	Make system settings.
21	SYSTEM 2	

The various menu items are as follows.

Menu item	Function	Page
PLAY 1 page		
PLAY AREA	Playback area setting	see page 30
PLAY MODE	Playback mode setting	see page 31
REPEAT	Repeat playback function settings	see page 34
AUTO CUE	Auto cue function settings	see page 34
AUTO READY	Auto ready function setting	see page 35
PLAY 2 page		
INCREMENTAL PLAY	Incremental playback function setting	see page 35
MONO MIX	Mono playback function setting	see page 35
DUCKING	Ducking function settings	see page 36
EOM TRACK	EOM function settings	see page 36
EOM MEDIA		
PLAY 3 page		
RESUME	Resume playback function setting	see page 37
TIME SKIP	Time skip function setting	see page 37
FADER DELAY	Playback start timing setting	see page 38

2 – Names and Functions of Parts

Menu item	Function	Page
OUTPUT RATE	Audio output setting for external sampling frequency synchronization	see page 38
CALL	Call function setting	see page 38
PLAYLIST page		
PLAYLIST EDIT	Playlist editing	see page 46
REC 1 page		
INPUT SELECT	Input source selection	see page 52
REC SET LINK	Input channel link setting	see page 53
BAL. INPUT GAIN	Mic input sensitivity setting	see page 54
INPUT LEVEL	Input volume setting	see page 54
MIC PHANTOM	Phantom power setting	see page 55
REC 2 page		
MIC AGC	Automatic gain control for mic input function setting	see page 55
DYNAMICS	Dynamics function setting	see page 56
LOW CUT	Low-cut filter setting	see page 56
REC 3 page		
REC FORMAT	Recording file format setting	see page 57
BACKUP/RELAY MEDIA	Backup and relay recording media settings	see page 57
WAV SETTING	WAV file settings	see page 58
MP3 BITRATE	MP3 file bit rate setting	see page 58
STEREO/MONO	Recording input channel setting	see page 58
REC 4 page		
FILE NAME	Set the file name format	see page 59
DITHER	Dither setting	see page 60
SRC	Sampling rate converter setting	see page 60
PAUSE MODE	Pause mode function setting	see page 60
DIRECT REC	Direct record function setting	see page 60
REC 5 page		
PRE REC	Pre-recording function setting	see page 61
SYNC REC	Synchronized recording settings	see page 61
AUTO TRACK	Automatic track incrementation function settings	see page 62
AUTO MARK	Automatic mark function settings	see page 64
TIMER EVENT page		
TIMER EVENT	Timer event function setting	see page 69
TIMER EVENT LIST	Timer event list screen settings	see page 69
MARK LIST page		
MARK LIST	Mark list editing	see page 75
NETWORK 1 page		

Menu item	Function	Page
MAC ADDRESS	View the unit's MAC address	see page 78
IP ADDRESS	View the current IP address	
DNS ADDRESS	View the IP address of the DNS server	
IP SETUP	Set the unit's IP address and related settings	see page 78
DNS SETUP	Set the IP address of the DNS server	
NETWORK 2 page		
IP PASSWORD	Password setting	see page 79
FTP CLIENT page		
TARGET FTP SERVER	Various settings for FTP server connections	see page 79
FTPS MODE	FTP mode setting	
TARGET FOLDER NAME	Set default folder for FTP server uploads and downloads	
ACCESS TEST	Test connection with FTP server	
AUTO UPLOAD	Automatic uploading to FTP server setting	
SNTP page		
SNTP STATUS	View the current SNTP status	see page 82
SNTP UPDATE	Set the SNTP function update mode	
NTP SERVER	NTP server name setting	see page 82
TIMEZONE	Set the time offset from Coordinated Universal Time (UTC)	
DAYLIGHT SAVING	Set the daylight savings time function	
UTILITY page		
LINK PLAY	Link playback settings	see page 39
POWER ON ACTION	Power on action function setting	see page 84
OUTPUT LEVEL	Analog output attenuation function setting	see page 84
PREFERENCES page		
REFERENCE LEVEL	Reference level setting	see page 84
BRIGHTNESS	Display and indicator brightness setting	see page 26
LCD CONTRAST	Display contrast setting	see page 26
KEYBOARD	Keyboard type setting	see page 84
REMOTE page		
RS-232C	RS-232C settings	see page 90
RC-3F	RC-3F mode setting	see page 90
MEDIA page		
MEDIA FORMAT	Media formatting settings	see page 28
MEDIA INFORMATION	View media information	see page 87

2 – Names and Functions of Parts

Menu item	Function	Page
SYSTEM 1 page		
CLOCK ADJUST	Date and time settings	see page 26
FACTORY PRESET	Restore factory default settings	see page 87
SAVE USER PRESET	Write user settings	see page 87
LOAD USER PRESET	Load user settings	see page 87
SYSTEM BACKUP	Import/export system backup data	see page 88
SYSTEM 2 page		
VERSION	View the firmware version	see page 89
UPDATE	Update the firmware	see page 89

NOTE

The settings for all menu items are retained even when the unit is turned off.

Basic Menu Screen operations

Use the following operations to work with the pages of the Menu Screen.

Changing menu items by page:

Press the **MENU [JOG]** button repeatedly until the desired menu page opens.

The pages will open in the following order.

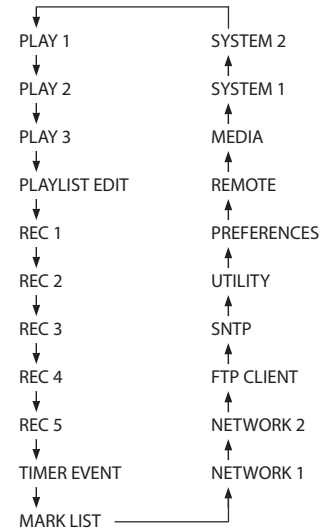

NOTE

- Press the **MENU [JOG]** button while pressing and holding the **SHIFT** button to open menu pages in the opposite direction.
- Turn the **MULTI JOG** dial to move up and down on the menu screen one item at a time from the **PLAY 1** page **PLAY AREA** item to the **SYSTEM 2** page **UPDATE** item.

Selecting items (moving vertically on a page):

Turn the **MULTI JOG** dial.

Confirming a selected item:

Press the **MULTI JOG** dial.

Opening a submenu from a page:

Press the **MULTI JOG** dial.

Selecting an item in a submenu:

Press the **MULTI JOG** dial or **◀ [A-B] / ▶ [INPUT]** button.

Going back one step in a menu:

Press the **MENU [JOG]** button.

Returning directly to the Home Screen from a menu screen:

Press the **HOME [INFO]** button.

2 – Names and Functions of Parts

Menu operation procedures

In this example, we explain how to set the auto mark function.

1. Press the **MENU [JOG]** button to open the PLAY 1 menu page.

PLAY 1	1/21
PLAY AREA	ALL
PLAY MODE	CONTINUE
REPEAT	OFF
AUTO CUE	OFF
AUTO READY	OFF

2. Press the **MENU [JOG]** button to open other menu pages.

REC 5	9/21
PRE REC	OFF
SYNC REC	OFF
AUTO TRACK	LEVEL
AUTO MARK	ON

REC 5 page open

3. Turn the **MULTI JOG** dial to select the item to set.

REC 5	9/21
PRE REC	OFF
SYNC REC	OFF
AUTO TRACK	LEVEL
AUTO MARK	ON

AUTO MARK selected

4. Press the **MULTI JOG** dial to open the settings screen.

AUTO MARK	<< >>: MOVE Cursor
OVER	OFF
TIME	1min
UNLOCK	ON
REC	OFF
BOF	ON

AUTO MARK screen open

5. Turn the **MULTI JOG** dial to change the setting.
6. To set another item on the same screen, press the **MULTI JOG** dial to move the cursor to the next setting.
When you can use the ◀◀ [A-B] and ▶▶ [INPUT] buttons to move the cursor, "<< >>: MOVE Cursor" will appear at the top right of the screen.
7. Repeat steps 5 to 6 as necessary to set other items.
8. Press the **MULTI JOG** dial to confirm the setting changes and return to the Menu Screen.
Press the **HOME [INFO]** button to return to the Home Screen.

NOTE

- Press the **MENU [JOG]** button to cancel the menu operation and return to the Menu Screen.
- In some cases, in step 8, pressing the **MULTI JOG** dial will return to the Home Screen immediately.
- Menu items that cannot be changed are shown inside brackets [], and cannot be selected using the **MULTI JOG** dial.

Making connections

This is an example of SS-R250N connections.

Precautions before making connections

- Carefully read the operation manuals of the devices to be connected and then connect them correctly.
- Before making connections, turn this unit and all equipment to be connected off (standby).
- Install all connected devices, including this unit, so that they are powered from the same line. When using a power strip or similar device, be sure to use one that has high current capacity (thick cable) in order to minimize fluctuations in power voltage.

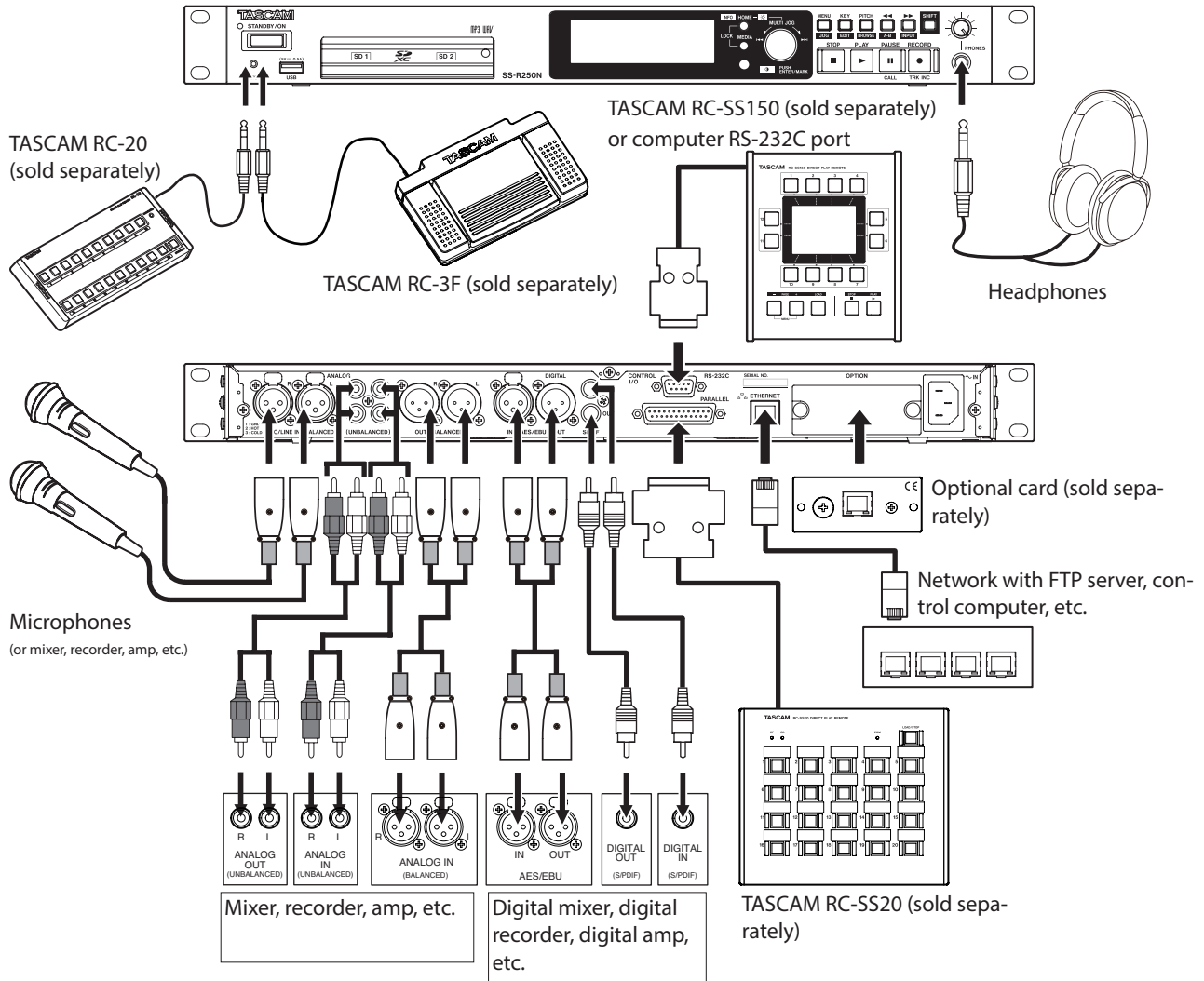

Examples of connections to a SS-R250N

3 – Preparation

Preparing the remote control

Installing the coin battery

NOTE

When this unit is purchased new, a lithium coin battery (CR2025) is preinstalled in the remote control. To use the remote control, remove the isolation sheet inserted in the battery holder.

1. Remove the battery holder from the remote control. While pressing ①, pull it in the ② direction.

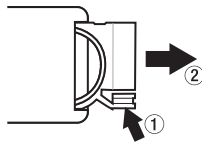

2. Being careful to maintain the correct \oplus / \ominus orientation, install the lithium coin battery (CR2025) into the battery holder.

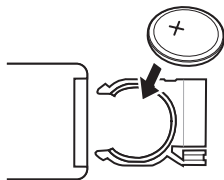

3. Insert the battery holder into the remote control.

When to replace the battery

Replace the battery with a new one if the distance from the main unit that the remote can be used decreases or if the unit stops responding to the remote buttons.

Use a lithium coin battery (CR2025).

Battery precautions

The accidental swallowing of lithium coin batteries by small children is extremely dangerous. Keep these batteries and this remote control in places where small children cannot reach them. Should a child swallow a battery, consult with a doctor immediately.

Misuse of batteries could cause them to leak or rupture, for example. Carefully read and follow the caution labels on batteries. (see "CAUTIONS ABOUT BATTERIES" on page 4)

- Install lithium coin batteries with the correct orientation.
- Do not charge lithium coin batteries.
- Do not heat or disassemble lithium coin batteries. Do not put them in fire or water.
- Do not transport or store lithium coin batteries with small metal objects. Doing so could cause the batteries to short and leak or rupture, for example.
- When storing and disposing of them, isolate their terminals with tape, for example, so that they do not touch other batteries or metal objects.
- Dispose of used batteries according to the instructions on them and the requirements set by your local government.

Using the wireless remote control

See Wireless remote control (TASCAM RC-10) page 16 for the button functions.

When using the remote control, point it toward the receiver on the unit and use it within the range shown below.

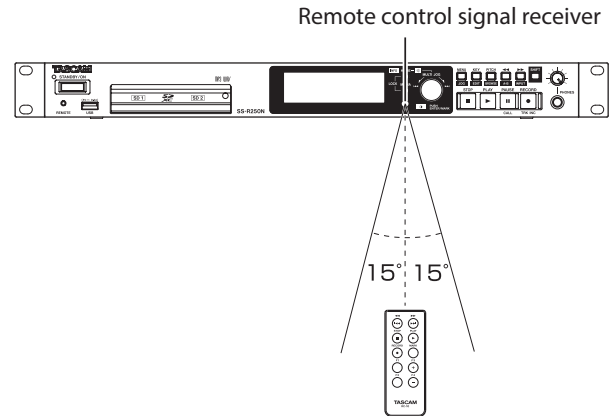

Remote control operation range

Front: 7 m

Angle: ± 15 degrees

CAUTION

- The range will vary according to the angle.
- Operation might not be possible if there are obstacles.
- Remove the battery if not using the remote control for a long time (a month or more).
- If battery fluid should leak, wipe away any fluid inside the case thoroughly and install a new battery.
- When using other devices that can be controlled by infrared rays, operation of this remote control could cause those devices to function improperly.

Installing a Dante interface card (sold separately)

CAUTION

Before installing or removing a Dante interface card (sold separately), disconnect the power cord from the outlet or the unit.

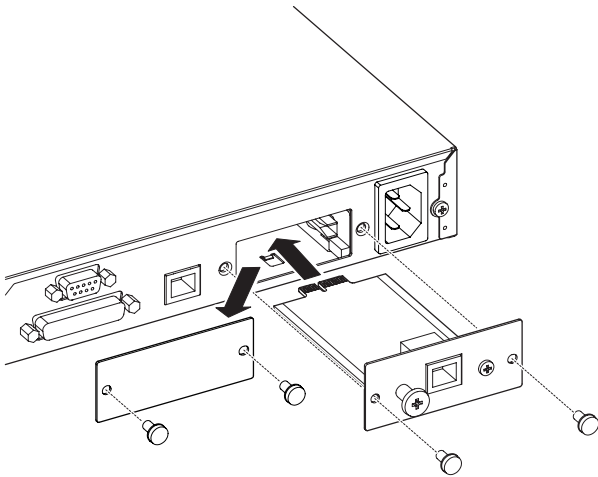

1. Remove the two screws from the plain panel and remove the panel itself.
2. Insert the Dante interface card into the card slot. Align the edges of the Dante interface card with the white guides inside the slot and insert it securely. Push the Dante interface card in until its backplate reaches the back panel of the unit, leaving no gap, and clicks into place. Do not force the card into the slot. If you cannot insert the card properly, remove it once and try reinserting it.
3. Use the two removed screws to secure the Dante interface card in place.
4. Turn this unit on.

When the unit recognizes the Dante interface card, IF-DA2 (DANTE) will become available as an input source setting on the INPUT SELECT screen. (see "Selecting the input source" on page 52)

If IF-DA2 (DANTE) does not appear as an option on the INPUT SELECT screen, the Dante interface card might not be inserted correctly or the screws might not be tightened securely. Insert the Dante interface card securely into the unit again.

Turning the unit on and off

Press the **STANDBY/ON** button on the front of the unit to turn it on.



Startup screen



Home Screen

After the unit starts and the startup screen is shown, the Home Screen will open.

If no current medium is loaded or there are no audio files in the current folder, the track number and time will not be shown on the Home Screen.

Turning the unit off:

1. Press and hold the **STANDBY/ON** button to open a pop-up message.
2. When the confirmation pop-up is open, press and hold the **MULTI JOG** dial to turn the unit off.

CAUTION

- Do not disconnect the power cord when the unit is operating (including recording, playing back, or writing data to an SD card or USB flash drive). Doing so could cause proper recording to fail, recorded data to be lost, and sudden loud noises from monitoring equipment, which might damage the equipment, harm hearing or cause other trouble.
- When the unit is started up for the first time (or when the built-in clock is reset after being left unused without power for a long time), the CLOCK ADJUST screen appears before the start-up screen to allow the date and time of the built-in clock to be set. (see "Setting the built-in clock date and time" on page 26)

NOTE

Press the **MENU [JOG]** button briefly to not turn the unit off.

3 – Preparation

Setting the built-in clock date and time

Using its internal clock, this unit includes the date and time when a file is recorded.

1. Select the **CLOCK ADJUST** item on the **SYSTEM 1** page to open the **CLOCK ADJUST** screen.(see “Menu operation procedures” on page 22)

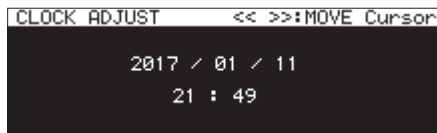

2. Press the **MULTI JOG** dial to enter setting mode and show the cursor on the item to be changed.

Use the **◀ [A-B]** and **▶ [INPUT]** buttons to move the cursor.

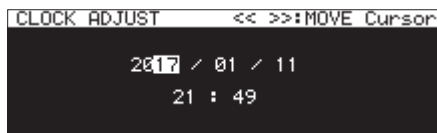

3. Turn the **MULTI JOG** dial to change a value, and press the **MULTI JOG** dial to confirm it and move the cursor to the next item.
4. The cursor will disappear and setting the date and time will complete after you change the year, month, day, hour and minute in order.

NOTE

When making a setting, you can press the **MENU [JOG]** button to cancel the changes and return to the Menu Screen.

5. Confirm the setting and return to the Menu Screen.

Adjusting the display

You can adjust the contrast and brightness of the display as well as the brightness of the **PLAY**, **PAUSE [CALL]** and **RECORD [TRK INC]** buttons as necessary.

Adjusting the display and indicator brightness

Adjusting with controls

While pressing the **HOME [INFO]** button, turn the **MULTI JOG** dial to adjust the brightness of the display and indicators.



Adjusting with the menu setting

1. Select **BRIGHTNESS** on the **PREFERENCES** page to open the **BRIGHTNESS** screen.(see “Menu operation procedures” on page 22)



2. Adjust the display and indicator brightness.
Options: 0 – 10 (default: 5)
3. Confirm the setting and return to the Menu Screen.

Adjusting the display contrast

Adjusting with controls

While pressing the **SHIFT** button, turn the **MULTI JOG** dial to adjust the display contrast.



Adjusting with the menu setting

1. Select **LCD CONTRAST** on the **PREFERENCES** page to open the **LCD CONTRAST** screen.(see “Menu operation procedures” on page 22)



2. Adjust the display contrast.
Options: 0 – 50
3. Confirm the setting and return to the Menu Screen.

Inserting and removing SD cards

Inserting SD cards

Insert an SD card into an SD card slot on the front of the unit to enable playback and recording by this unit.

NOTE

SD cards can be inserted whether or not the unit is on or off (in standby).

1. Pull the SD card slot cover forward to open it.

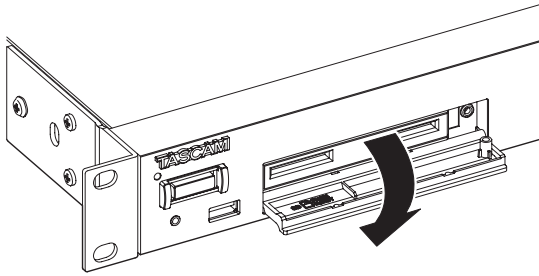

2. Inserted SD cards with the correct orientation. The label should be up and the connector should be inserted toward the back.

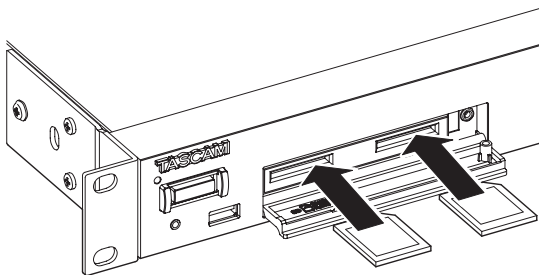

3. Close the card slot cover.

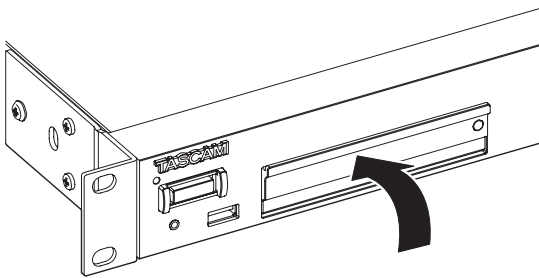

NOTE

If the SD card slot cover cannot be closed, remove the SD card and insert it again.

Removing SD cards

Turn the unit off or stop operation before removing an SD card.

CAUTION

Never remove an SD card from the unit when it is being accessed, such as in the cases listed below. Doing so could cause proper recording to fail, recorded data to be lost, and sudden loud noises from monitoring equipment, which might damage the equipment, harm hearing or

cause other trouble.

Moreover, removing a card during FIRMWARE UPDATE execution could result in the unit becoming unable to start up or operate properly.

- When recording
- During playback
- During SYSTEM BACKUP IMPORT or EXPORT execution
- During FIRMWARE UPDATE execution (see "Firmware update procedures" on page 89)
- When the BROWSE screen is open and the SD card is being accessed

1. Pull the SD card slot cover forward to open it.
2. Press the SD card in gently to make it to come forward.

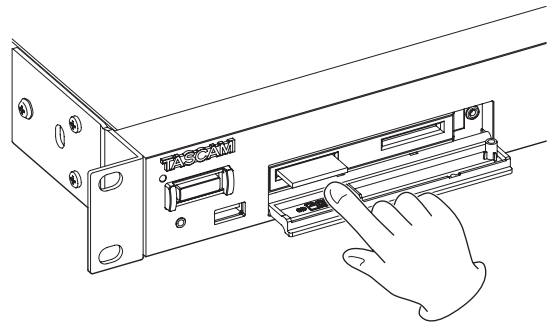

3. Pull the SD card out by hand.

Using the security screw

You can use the included security screw to lock the card slot cover switch.

Use a Phillips (+) driver to install/remove the security screw.

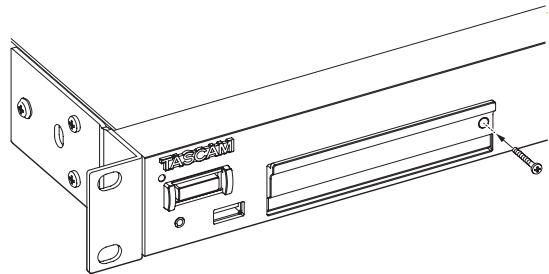

SD card write-protection switches

SD cards have write-protection switches that prevent writing new data to them.

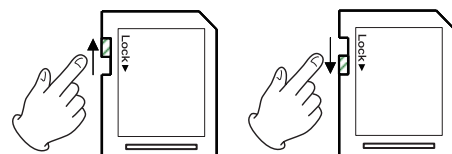

If you slide the protect switch to the LOCK position, file recording and editing will not be possible. Unlock cards to enable changing their data, including recording and erasing.

3 – Preparation

Connecting and disconnecting USB flash drives

You can connect and disconnect USB flash drives whether the unit is on or off.

CAUTION

Never disconnect a USB flash drive when it is being accessed, such as in the cases listed below.

Doing so could cause proper recording to fail, recorded data to be lost, and sudden loud noises from monitoring equipment, which might damage the equipment, harm hearing or cause other trouble.

Moreover, removing a card during FIRMWARE UPDATE execution could result in the unit becoming unable to start up or operate properly.

- When recording
- During playback
- During SYSTEM BACKUP IMPORT or EXPORT execution
- During FIRMWARE UPDATE execution (see “Firmware update procedures” on page 89)
- When the BROWSE screen is open and the USB flash drive is being accessed

Selecting media

Before conducting other operations, select the medium to use (USB, SD1 or SD2).

Follow the procedures below to select the medium.

1. Press the **MEDIA** button to open the MEDIA SELECT screen.

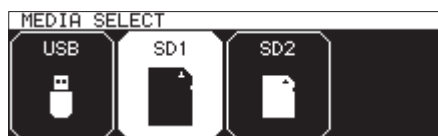

2. Press the **MEDIA** button to select the medium to use, and press the **MULTI JOG** dial to confirm it.
3. The name of the currently selected medium appears in the current medium area of the Home Screen.

Current media name



USB: USB flash drive selected

SD1: SD card 1 selected

SD2: SD card 2 selected

Preparing SD cards and USB flash drives for use

In order to use an SD card or USB flash drive with this unit, you must use this unit to format it first.

CAUTION

- Formatting erases all the data on the SD card or USB flash drive.
- Always use this unit to format media to be used with it. Operation of this unit might be affected when using an SD card or USB flash drive that has been formatted by a computer or other device.

1. Open the MEDIA SELECT screen, and select the medium to format. (see “Selecting media” on page 28)
2. Select the MEDIA FORMAT item on the MEDIA page to open a format method option pop-up. (see “Menu operation procedures” on page 22)

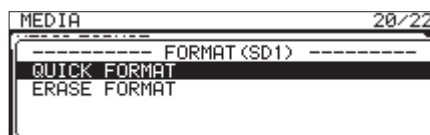

QUICK FORMAT: Format only system data on the medium.

ERASE FORMAT: Completely format the medium.

NOTE

The ERASE FORMAT item only appears when an SD card is selected as the current medium.

3. Select the format method, and press the **MULTI JOG** dial. A confirmation pop-up message appears.



NOTE

Press the MENU [JOG] button to cancel formatting.

4. Press the **MULTI JOG** dial to start formatting. The following pop-up message will appear during formatting.

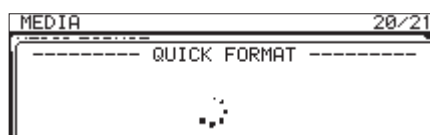

Pop-up when QUICK FORMAT selected

- When formatting completes, the pop-up disappears and the Home Screen opens.

NOTE

The writing speeds to SD cards and other storage media that use flash memory tend to decrease after writing occurs repeatedly.

If the writing speed decreases, this could have a negative impact on recording.

Using the ERASE FORMAT function of this unit should restore the writing speed of an SD card.*

For this reason, we recommend using the ERASE FORMAT function at the following times.

- Whenever the card has been written to until it became completely full
- On a regular schedule (about once per month)
- Before starting important recordings

*Writing speed might not be restored depending on the SD card condition (including malfunction and age).

Setting the lock function

You can set the lock function to prevent this unit from being controlled from its front panel or an external device.

- Press the **MEDIA** button while pressing the **HOME [INFO]** button on the front of the unit to open the **LOCK SETUP** screen.



- Select the lock function to set, and open the lock function setting screen. (see “Menu operation procedures” on page 22)



Lock function setting screen when **FRONT PANEL** item selected

FRONT PANEL

This locks the controls on the front of the unit.

Options: UNLOCK (default), LOCK

232C/PARA/NETWORK

This locks external control from the **RS-232C** and **PARALLEL** connectors, as well as file transfer and remote control by Telnet using an FTP client application.

Options: UNLOCK (default), LOCK

REMOTE/KEYBOARD

This locks operation using a remote control connected to the REMOTE jack or a USB keyboard or numeric keypad.

Options: UNLOCK (default), LOCK

NOTE

The following operations are possible even when set to **LOCK**.

- Showing the Home Screen
- Changing settings on the **LOCK SETUP** screen
- Turning the power off with the **STANDBY/ON** button
- Adjusting the brightness of the display and various indicators

- Confirm the setting and return to the Menu Screen.

Opening the INFORMATION screen

While pressing the **SHIFT** button, press the **HOME [INFO]** button to show the operation status of the unit on the display.



Contents

CLOCK

Sampling frequency currently used for operation

INPUT

Currently set input

FILE

Currently set file type, quantization bit depth and file mode

Recording date

Current folder now selected

NOTE

If **DIGITAL XLR**, **DIGITAL COAXIAL** or **IF-DA2 (DANTE)** (only when **IF-DA2** card installed) is selected, recording cannot be started from recording standby under the following conditions.

- If this unit is not digitally locked to the input source, “{UNLOCK}” will appear at the end of the input source name.
- If the input source is not audio, “{Not Audio}” will appear.
- If the sampling frequency set with the **SAMPLE** item on the **REC 3** page differs from the input source, “{FS UNMATCH}” will appear at the end of the input source name. If the sampling rate converter is active, however, recording will be possible even if the sampling frequency is different. (see “Using the sampling rate converter” on page 60)

4 – Playback

This chapter explains functions for playing back audio files stored on SD cards and USB flash drives.

This explanation assumes that you have already loaded an SD card or USB flash drive that contains audio files into the unit, that the unit is on, and that the current medium is set appropriately. (see “Selecting media” on page 28)

Files that can be played back

This unit can play back files in the following formats.

- MP3: 44.1/48kHz, 64/128/192/256/320kbps
- WAV/BWF: 44.1/48/96kHz, 16/24-bit

CAUTION

MP3 files that use VBR compression

Due to file format limitations, accurate location detection is not possible in VBR files. For this reason, when using functions that require points to be set in the middle of a track, including time skipping, call and A-B repeat playback (A point setting), slight differences might occur between the set point and the point where playback begins.

TIP

Files of the above formats can be played back by this unit even if it was not used to record them. For example, you can use a computer or another audio device to write files that meet the above specifications to an SD card or USB flash drive, and then play those files on this unit. This allows you to efficiently prepare materials for playback on this unit.

Tracks and files

Audio data are recorded as “audio files” on media.

When the CHANNEL item on the STEREO/MONO screen is set to STEREO, stereo files will be handled as single tracks. When set to MONO (MIX), mono files will be handled as single tracks. When set to MONO (2ch), pairs of mono files will be handled as single tracks. (see “Setting the recording file format” on page 57)

For this reason, when explaining playback and recording in this document, we call audio files “tracks” (and sometimes “songs”). When explaining media management and related topics, we call them “files”. Please understand that they are the same thing.

Playback area

The range of tracks that can be selected for playback on the Home Screen is called the “playback area”.

Limiting the playback area makes selection of playback tracks easier when you have numerous recorded files on the SD card or USB flash drive.

Setting the playback area

Use the PLAY AREA item on the PLAY 1 page to set the playback area.

1. Select the PLAY AREA item on the PLAY 1 page to open the PLAY AREA screen. (see “Menu operation procedures” on page 22)



2. Set the desired playback area.

Option	Meaning
ALL (default)	Play all the files on the medium.
FOLDER	Play all the files in the folder that contains the currently selected file.
PLAYLIST	Play all the files that have been assigned to the playlist. If there is no playlist defined, a No PLAYLIST pop-up appears.

3. Confirm the setting and return to the Menu Screen.

NOTE

The current playback area setting appears at the lower right of the Home Screen.



Playback area

Selecting the current folder or current playlist

When the playback area is set to FOLDER or PLAYLIST, the Home Screen is open and the unit is stopped, you can use the ◀ [A-B] and ▶▶ [INPUT] buttons on the unit to select a folder or playlist as the playback area.

This folder or playlist is called the “current folder” or “current playlist”.

NOTE

- You can also select the current folder or current playlist on the BROWSE screen. (see “5 – Working with Folders and Files (BROWSE screen)” on page 40)
- Up to 999 tracks can be played back by this unit if the formats of the audio files are MP3 or WAV.

If a medium with more than 999 tracks is loaded in this unit, 999 tracks selected according to the unit’s system rules can be played. Any other tracks will not be playable or editable.

Setting the play mode

The mode used to play tracks in the playback area can be set.

1. Select **PLAY MODE** on the **PLAY 1** page to open the **MODE AREA** screen.(see “Menu operation procedures” on page 22)



2. Set the desired play mode.

Option	Meaning
CONTINUE (default)	Play tracks in the playback area in track number order.
SINGLE	Play the selected track, and stop after playback.
PROGRAM	Play in program order set in advance.(see “Program playback” on page 32)
RANDOM	Play all tracks in the playback area in random order regardless of track number. Stop playback after all tracks have been played.

3. Confirm the setting and return to the Menu Screen.

NOTE

- Unless otherwise specified, explanations in this manual assume that the playback mode is set to **CONTINUE**.
- The current playback mode appears in the lower right of the Home Screen.

Basic playback operations

This section explains basic playback operations, including starting, stopping and pausing.

This explanation assumes that you have already made necessary connections, turned the unit on, loaded a card or drive that contains audio files, selected the current medium, and opened the Home Screen on the display.

Playing tracks

Press the **PLAY** button on the unit or the remote control to start playback.

If the medium does not contain any audio files that the unit can play, the Home Screen will appear as shown below.



Stopping playback:

Press the **STOP** button.

Pausing playback:

Press the **PAUSE [CALL]** button.

Selecting tracks for playback

This section explains how to select a track when there are multiple tracks available for playback. The two ways to select tracks are moving (skipping) backward/forward by track number and specifying track numbers directly.

Skipping to earlier and later tracks

Turn the **MULTI JOG** dial (or use the remote control **◀◀ [I◀◀]** and **▶▶ [▶▶I]** buttons) to skip to earlier and later tracks.

- During track playback, turn the **MULTI JOG** dial counterclockwise (or press the remote control **◀◀ [I◀◀]** button) to return to the track beginning. When already at the beginning of a track, turn the **MULTI JOG** dial counterclockwise (or press the remote control **▶▶ [▶▶I]** button) to skip to the beginning of the previous track.
- When at the beginning or middle of a track, turn the **MULTI JOG** dial clockwise (or press the remote control **▶▶ [▶▶I]** button) to skip to the beginning of the next track.

After selecting a track, press the **PLAY** button (or remote control **PLAY** button) to start playing it back. Press the **PAUSE [CALL]** button to pause playback at the beginning of the selected track.

NOTE

- Only tracks in the current playback area can be played back.
- The track number, file name and other file information for the currently playing file appear on the display.
- Turn the **MULTI JOG** dial as necessary to move between tracks.

Selecting tracks directly

On the **BROWSE** screen, turn the **MULTI JOG** dial (or use the remote control **◀◀ [I◀◀]** and **▶▶ [▶▶I]** buttons) to select the track you want to play, and press the **PLAY** button (or remote control **PLAY** button) to start playback.

4 – Playback

Searching backward and forward

You can search backward and forward within a track while listening to it.

1. Play or pause the desired track.
2. Press and hold the ◀◀ [A-B]/▶▶ [INPUT] button on the unit (or remote control ◀◀ [◀◀]/▶▶ [▶▶] button). Searching backward/forward will start.
3. To stop searching, release the button you are pressing. The state (playing or paused) before searching started will resume.

Jog playback

You can put the unit into jog playback mode, and use the **MULTI JOG** dial to search in 10msec increments.

1. Press the **MENU [JOG]** button while pressing the **SHIFT** button to activate jog playback mode. The **PLAY** and **PAUSE [CALL]** buttons on the unit will blink, and the track elapsed time will be shown with 10msec increments on the Home Screen in **TRACK** display mode.

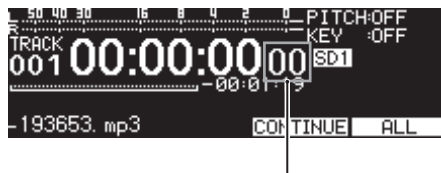

10msec increments

2. Turn the **MULTI JOG** dial to search.
3. To end jog playback mode, press the **STOP, PLAY** or **PAUSE [CALL]** button to use its function (stop, playback from or pause at the search position).

Program playback

By setting a program in advance, you can play the desired tracks in the desired order. Up to 99 tracks can be assigned to the program.

Setting the program

Follow the procedures below to set the program.

1. When stopped, set the playback mode to **PROGRAM**. (see "Setting the play mode" on page 31)
2. Turn the **MULTI JOG** dial to select a track number, and press the **MULTI JOG** dial to assign it to the program. This assigns the track to the program.
3. Repeat step 2 to assign desired tracks to the program in order. The program number and total time appear on the display.

NOTE

- The same track can be assigned to the program multiple times.
 - While pressing the **SHIFT** button, press the **KEY [EDIT]** button to remove the last assigned track from the program.
 - If you try to assign more than 99 tracks to the program, a **PROGRAM FULL** pop-up will appear. Up to 99 tracks can be assigned to the program.
 - If the total time of the programmed tracks exceeds 99:59:59, " - : - : - " appears on the display.
4. Press the **PLAY** button to start program playback.

NOTE

- When the playback mode is set to **PROGRAM**, playback is not possible if no tracks have been assigned to the program.
- When the playback mode is changed, all program data will be cleared.
- When stopped, pressing the **STOP** button will clear all program data
- Program data will be cleared when the unit is turned off.

Using the pitch control function

Using the pitch control function, you can change the pitch (sound frequency and playback speed) of playback.

Turning the pitch control function on/off

1. When the Home Screen is open, press the **PITCH [BROWSE]** button to open the pitch setting pop-up window, and press the **MULTI JOG** dial to turn pitch control on/off.



2. Press the **MENU [JOG]** or **PITCH [BROWSE]** button to close the pitch setting window, and complete the setting.

NOTE

- The pitch control function setting is shown at the top right of the Home Screen.



- If you turn the pitch control function on/off during playback, the playback sound might skip momentarily.

Adjusting the pitch

1. Press the **PITCH [BROWSE]** button to open the pitch setting pop-up window.
2. Turn the **MULTI JOG** dial to change the pitch.



Setting range: -16% – +16.0% (default: 0.0%) in 1% increments

3. Press the **MENU [JOG]** or **PITCH [BROWSE]** button to close the pitch setting window, and complete the setting.

NOTE

- Press and turn the **MULTI JOG** dial to change the pitch in 0.1% increments.
- The set pitch adjustment is retained even when the pitch control function is turned off and will be applied when the function is turned on again.

TIP

By using the key control and pitch control functions together, you can change the speed without changing the pitch. (see "Using the key control function" on page 33)

Using the key control function

The key control function can be used to change the key (pitch in semitones) during playback.

Turning the key control function on/off

1. When the Home Screen is open, press the **KEY [EDIT]** button to open the key setting pop-up window, and press the **MULTI JOG** dial to turn key control on/off.



2. Press the **MENU [JOG]** or **KEY [EDIT]** button to close the key setting window, and complete the setting.

CAUTION

- The key control function setting is shown at the top right of the Home Screen.



- When using the control function, the playback sound might seem to fluctuate. This is the result of special processing of the playback sound and is not a malfunction.

Setting the key

1. Press the **KEY [EDIT]** button to open the key setting pop-up window.
2. Turn the **MULTI JOG** dial to change the key.



Setting range: b6 – b1, 0 (default, no key change), #1 – #6

3. Press the **MENU [JOG]** or **KEY [EDIT]** button to close the key setting window, and complete the setting.

TIP

When both the key control and pitch control functions are on, the key control function sets the key (pitch in semitones) and the pitch control function sets the speed (but not the pitch). Therefore, you can use pitch control to change only the playback speed without changing the pitch when the KEY is set to 0 and the key control function is on.

4 – Playback

Using the repeat playback function

All tracks in the playback area can be played back repeatedly. Specified intervals within a track can also be played back (A-B repeat playback).

Ordinary repeat playback settings

When the repeat playback function is on, operation depends on the playback mode setting.

Playback mode setting	Function
CONTINUE	Repeat playback of the playback area set on the PLAY AREA screen
SINGLE	Repeat playback of the current track
PROGRAM	Repeat playback of the entire program
RANDOM	Repeat playback in random order of the playback area set on the PLAY AREA screen

Follow the procedures below to turn the repeat playback function on.

1. Select REPEAT on the PLAY 1 page to open the REPEAT screen.(see “Menu operation procedures” on page 22)



2. Turn the repeat function on or off.
Options: OFF (default), ON
3. Confirm the setting and return to the Menu Screen.

A-B repeat playback settings

Specified intervals within a track can be played back (A-B repeat playback). Follow the procedures below to use A-B repeat playback.

1. When playing back or in playback standby, press the ◀◀ [A-B] button while pressing the SHIFT button at the point where you want the repeat playback interval to start (A). On the Home Screen, -- A-B Repeat -- and A-B appear in a pop-up.



2. Press the ◀◀ [A-B] button again while pressing the SHIFT button at the point where you want the repeat playback interval to end (B).

On the Home Screen, -- A-B Repeat -- and A-B appear in a pop-up.



This confirms the set interval (A-B) and starts A-B repeat playback.

NOTE

- Press the STOP button on the unit or the remote control to clear the set interval (A-B).
- The A-B repeat playback interval cannot include more than one track.

Using the auto cue function

If the auto cue function is on, when a track is selected, the unit will skip any silence at the beginning of the track and pause at the point where sound actually starts. As a result, sound will be output immediately after playback starts.

The threshold level (auto cue level) for the audio signal detection used by the auto cue function can also be set. In short, the unit will treat signals above the auto cue level as sound and signals below the auto cue level as silence.

NOTE

When the auto cue function is on, if a track is selected during playback, it will start playing from the point where sound is first detected.

If a track is selected when playback is paused, playback will pause at the point where sound is first detected.

Select AUTO CUE on the PLAY 1 page to open the AUTO CUE screen.(see “Menu operation procedures” on page 22)



NOTE

When the AUTO CUE screen is open, use the ◀◀ [A-B] and ▶▶ [INPUT] buttons to move the cursor between setting items.

Turn the auto cue function on/off

Select MODE and turn the auto cue function on/off.

Options: OFF (default), ON

Set the auto cue level

Select LEVEL and set the auto cue level.

Options: -72dB, -66dB, -60dB, -54dB (default), -48dB, -42dB, -36dB, -30dB, -24dB

NOTE

When the auto cue function is on, the AUTO CUE icon appears in the playback screen function activation status area.

Using the auto ready function

If the auto ready function is on, after playback of a track completes, playback will pause at the beginning of the next track.

1. Select **AUTO READY** on the **PLAY 1** page to open the **AUTO READY** screen.(see “Menu operation procedures” on page 22)



2. Turn the auto ready function on or off.
Options: OFF (default), ON
3. Confirm the setting and return to the Menu Screen.

NOTE

- When the auto ready function is on, the **AUTO READY** icon appears in the playback screen function activation status area.
- If the auto cue function is also on, playback will pause at the point where sound starts rather than the beginning of the track.
- When playing back using the flash start function, the auto ready function is disabled.

Using the incremental playback function

When the incremental playback function is on, press the main unit or remote control **PLAY** button during playback to start playback from the beginning of the next track, or press the main unit or remote control **STOP** button during playback to pause at the beginning of the next track.

1. Select **INCREMENTAL PLAY** on the **PLAY 2** page to open the **INCREMENTAL PLAY** screen.(see “Menu operation procedures” on page 22)



2. Turn the incremental playback function on or off.
Options: OFF (default), ON
3. Confirm the setting and return to the Menu Screen.

NOTE

- When the incremental playback function is on, the **INC. PLAY** icon appears in the playback screen function activation status area.
- When the incremental playback function is on and playback is paused, press the main unit or remote control **PLAY** button to start playback from that point.

When playback is paused press the main unit or remote control **STOP** button to stop playback. When the last track is playing back, press the main unit or remote control **PLAY** button to start playback from the beginning of the first track in the playback area, or press the main unit or remote control **STOP** button to pause at the beginning of the first track in the playback area.

Playing back in mono

Stereo audio files can be played back in mono. The left and right track channel signals are mixed together, and this mix is output from both the left and right channels.

1. Select **MONO MIX** on the **PLAY 2** page to open the **MONO MIX** screen.(see “Menu operation procedures” on page 22)



2. Turn the mono playback function on or off.
Options: OFF (default), ON
3. Confirm the setting and return to the Menu Screen.

4 – Playback

Using the ducking function

When the ducking function is active, signals input to this unit and playing back from the recorder are mixed and output. Select DUCKING on the PLAY 2 page to open the DUCKING screen. (see “Menu operation procedures” on page 22)



NOTE

- When the DUCKING screen is open, use the ◀◀ [A-B] and ▶▶ [INPUT] buttons to move the cursor between setting items.
- When the ducking function is active, ducking tally signals are output from the PARALLEL connector.

Input source information display

This shows the selected input source. (see “Selecting the input source” on page 52)

Setting the ducking function operation mode

Select MODE, and set the ducking function operation mode.

Option	Meaning
OFF (default)	The ducking function is disabled.
ATT. INPUT	When the recorder playback signal level exceeds the THRESHOLD level setting, the analog input signal is reduced by the ATTENUATION level setting.
ATT. PLAYBACK	When the input signal level exceeds the THRESHOLD level setting, the recorder playback signal is reduced by the ATTENUATION level setting.

Setting the ducking threshold level

Select THRESHOLD, and set the ducking operation threshold level.

Options: -30dBFS, -24dBFS, -18dBFS, -12dBFS, -6dBFS (default)

Setting the ducking attenuation (reduction) level

Select ATTENUATION, and set the ducking attenuation (reduction) level.

Options: -INFINITY, -24dB, -18dB, -12dB, -9dB, -6dB, -3dB (default)

Setting the time until ducking stops after the signal goes below the threshold level

Select RELEASE TIME, and set the time until ducking stops after the signal goes below the threshold level.

Options: 0.1sec (default), 0.5sec, 1.0sec, 1.5sec, 2.0sec, 2.5sec, 3.0sec, 3.5sec, 4.0sec, 4.5sec, 5.0sec

Using the EOM function

Turn the EOM function on to output an EOM tally signal from the PARALLEL connector when the remaining time of the track or playback area becomes less than a set time.

Setting the EOM tally output trigger

1. Select EOM TRACK or EOM MEDIA on the PLAY 2 page. (see “Menu operation procedures” on page 22)



EOM TRACK: Trigger with track remaining time

EOM MEDIA: Trigger with playback area remaining time

2. Set the amount of remaining time for the track or playback area that will trigger EOM tally signal output.

Options: OFF (default), 0sec – 99sec (in 1sec intervals)

NOTE

IF EOM TRACK is set to 0s a pulse of about 100ms will be output when the track finishes.

3. Confirm the setting and return to the Menu Screen.

Using this function

1. Connect the device to receive the EOM tally signal to the PARALLEL connector.
2. Turn this unit and the receiving device on.
3. Start playback on this unit.

When the remaining time of the track or playback area becomes less than the set time, an EOM tally signal will be output from the PARALLEL connector.

When both track and playback area triggers are set, an EOM tally signal will be output when either condition is met.

Using the resume function

When the resume playback function is on, playback can restart from the point where it was last stopped (resume point).

The following actions will clear the resume point.

- Ejecting the current media
- Changing the playback area
- Changing the playback mode
- Changing the contents of the current media (by recording, editing, deleting, etc.)

Use the menu to turn the resume playback function on/off.

1. Select **RESUME** on the **PLAY** 3 page to open the **RESUME** screen.(see “Menu operation procedures” on page 22)



2. Turn the resume playback function on or off.
Options: OFF, ON (default)
3. Confirm the setting and return to the Menu Screen.

NOTE

- If there are no playable tracks (when the playback mode is set to PROGRAM), all the counters will have a value of zero.
- If there is no resume point (no time has been set as the resume point), the beginning of the playback track will become the resume point.

Using the time skip function

When playing back or in playback standby, you can skip forward and backward by the amount of time set using the time skip function.

When playing back or in playback standby, press the main unit ◀◀ [A-B] or ▶▶ [INPUT] button (or remote control ◀◀ [◀◀] or ▶▶ [▶▶] button) to skip from the current position by the amount of time set with the time skip function.

After skipping time, the same operation will resume.

1. Select **TIME SKIP** on the **PLAY** 3 page to open the **TIME SKIP** screen.(see “Menu operation procedures” on page 22)



2. Set the amount of time skipped using the time skip function.
Range: OFF, 1sec – 60sec (default, 1sec intervals), 5min, 10min

NOTE

Skipping is disabled when the time skip function is OFF.

3. Confirm the setting and return to the Menu Screen.

NOTE

- If you press the main unit ◀◀ [A-B] button (or remote control ◀◀ [◀◀] button) when there is less time from the beginning of the track than the amount set by the track skip function, it will skip to the beginning of the current track.
- If you press the main unit ◀◀ [A-B] button (or remote control ◀◀ [◀◀] button) when less than one second from the beginning of a track, it will skip backward from the end of the previous track by the amount of time set with the track skip function.
- If it is the first track in the current media or program, it will pause at the beginning of the current track.
If the playback mode is set to RANDOM and you press the main unit m [A-B] button (or remote control m [.] button) when there is less time from the beginning of the track than the amount set by the track skip function, it will skip to the beginning of the track.
- If you press the main unit ▶▶ [INPUT] button (or remote control ▶▶ [▶▶] button) when there is less time to the end of the track than the amount set by the track skip function, it will skip to the beginning of the next track. If it is the last track in the current media or program, however, playback will pause at the end of the current track.

4 – Playback

Setting playback start timing

You can set the timing that playback starts when this unit is in playback standby and a fader on an external controller is raised from its lowest position (–∞).

1. Select **FADER DELAY** on the **PLAY** 3 page to open the **FADER START DELAY** screen.(see “Menu operation procedures” on page 22)



2. Set the playback start timing.
Range: OFF (default), 100msec, 200msec, 300msec
3. Confirm the setting and return to the Menu Screen.

Setting the sampling rate of output audio

You can output audio using a set sampling rate regardless of the sampling rates of the files.

1. Select the **OUTPUT RATE** item on the **PLAY** 3 page to open the **OUTPUT RATE** screen.(see “Menu operation procedures” on page 22)



2. Set the sampling rate used for output audio.

Option	Meaning
AUTO (default)	Use file sampling rates.
44.1kHz	Convert to 44.1 kHz and output.
48kHz	Convert to 48 kHz and output.
96kHz	Convert to 96 kHz and output.
EXTERNAL	Use sampling rate synchronized to input source clock. When an analog input is selected, this setting functions as AUTO.

NOTE

When set to **EXTERNAL**, if synchronization with the external clock is not possible, file sampling rates will be used.

3. Confirm the setting and return to the Menu Screen.

NOTE

Audio output from an **IF-DA2 (Dante)** card will use the card's operating sampling rate regardless of this setting.

Using the call function

The call function returns to the call point (last point playback started from playback standby) and resumes playback standby. When in playback standby, press the **PAUSE [CALL]** button to return to the last point playback started and resume playback standby.

The following actions will clear the call point.

- Turning the unit off
- Ejecting the current media
- Changing the playback area
- Changing the playback mode
- Changing the contents of the current media (by recording, editing, deleting, etc.)

NOTE

- If the call point is not set, pressing the **PAUSE [CALL]** button will cause a “No Call Point” pop-up warning message to appear.
- You cannot use the call function when the playback mode is set to **PROGRAM** or **RANDOM**.

Setting the call function

When in playback standby, press the **PAUSE [CALL]** button to search for the call point and resume playback standby.

1. Select **CALL** on the **PLAY** 3 page to open the **CALL FUNCTION** screen.(see “Menu operation procedures” on page 22)



2. Turn the call function on or off.

Options

- DISABLE:** Do not use call function
ENABLE (default): Use call function

NOTE

If the **CALL FUNCTION** screen setting is **DISABLE**, the unit will not search for call points.

3. Confirm the setting and return to the Menu Screen.

Using the link playback function

By using the link playback function, you can link the playback operations of a master unit to a slave unit.

The slave unit can be used as a playback backup.

The linked operations are playing back, entering playback standby, stopping, track skipping and searching. The synchronization of actions in response to operations, however, cannot be guaranteed.

In order to reduce delays in operation, whenever possible, use the same types of media from the same manufacturers with the same contents. In addition, make the same playback settings (auto cue, auto ready and other functions) and set the same flash load status, for example, on both units.

Clock is not synchronized, so a small difference in playback time could occur after playing back for a long time. Moreover, the digital connectors used for the link playback function cannot be used for audio input and output.

Making connections for link playback

Connect a digital output connector on the master unit to a digital input connector on the slave unit.

Connect either the **SPDIF IN/OUT** (RCA) or **AES/EBU IN/OUT** (XLR) connectors.

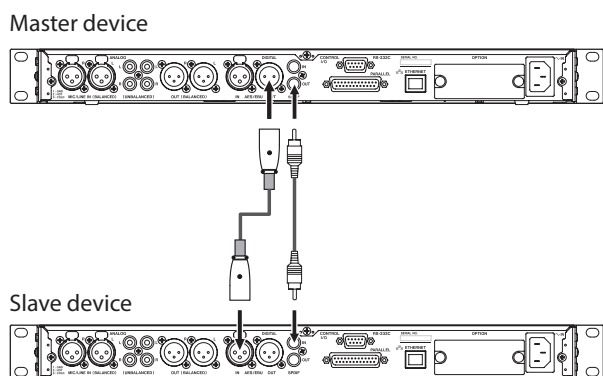

Making link playback settings

Select **LINK PLAY** on the **UTILITY** page to open the **LINK PLAY** screen. (see "Menu operation procedures" on page 22)



NOTE

When the **LINK PLAY** screen is open, use the **◀ [A-B]** and **▶ [INPUT]** buttons to move the cursor between setting items.

Making link playback mode settings

Select **MODE**, and set whether the unit is the master or the slave during link playback.

Options: OFF (default), MASTER, SLAVE

Setting the link playback connector

Select **TERMINAL**, and set the connector to use for link playback.

Option	Meaning
COAXIAL (default)	SPDIF IN/OUT connectors used
XLR	AES/EBU IN/OUT connectors used

Using the flash start function

The flash start function allows playback to be started immediately for tracks that have been registered in advance.

The starting points for up to 96 tracks can be loaded into memory so that playback of them can be started immediately. This can be controlled using a USB keyboard connected to the front of the unit, an external device connected to the **PARALLEL** connector on the back of the unit or a TASCAM RC-SS150 (sold separately) flash start remote control unit.

1. Set the playback area. (see "Playback area" on page 30)
Set the current playback area to a playlist or folder that contains the tracks you want to flash start.
2. Set the playback mode to **CONTINUE** or **PROGRAM**. (see "Setting the playback mode" on page 31)

NOTE

If the playback mode is set to **RANDOM**, flash loading is not possible.

3. When stopped, press the flash load button on the external controller.
This unit will load the starting point data for the tracks in the playback area in sequence.
When the playback mode setting is **CONTINUE**, they will be loaded in order from the first track. If it is **PROGRAM**, they will be loaded in program order.
While loading, the **FLASH LOAD** icon blinks on the Home Screen.
When loading completes, a **FLASH LOAD** pop-up appears on the Home Screen.

NOTE

- If the playback mode is set to **RANDOM**, pressing a flash load button on an external controller will open a "Cannot Select" pop-up message, and data will not be loaded.
 - If the playback mode is set to **SINGLE**, pressing a flash load button on an external controller will load tracks in order from the first track in the playback area in the same way as if set to **CONTINUE**.
 - When using a TASCAM RC-SS20 (sold separately), if more than 20 tracks have been registered, data for the first 20 in order will be loaded.
4. When the **FLASH LOAD** icon appears on the Home Screen, you can use a USB keyboard connected to the front of the unit or an external device connected to the **PARALLEL** connector to flash start tracks.
You can use **Ctrl + function (F1–F12)** keys to flash start tracks 1–12. (see "List of keyboard operations" on page 85)
When using the **PARALLEL** connector, you can flash start tracks 1–20. (see "PARALLEL connector overview" on page 15)

TIP

In the playback area is set to **PLAYLIST**, you can efficiently set flash starting for desired tracks by assigning them to a playlist and selecting it is the current playlist. (see "Playback area" on page 30), (see "6 – Editing Playlists" on page 46)

5 – Working with Folders and Files (BROWSE screen)

You can manage audio files on SD cards and USB flash drives in a folder structure.

After selecting a folder or file to work with on the **BROWSE** screen, you can open a folder or file pop-up menu.

In this menu, you can create folders, change the names of folders and files, delete them and assign files to playlists, for example. In addition, from the **BROWSE** screen, you can move and copy folders and files between folders.

NOTE

- *Using a computer to read the contents of SD cards and USB flash drives, you can change the folder structure, edit the names of folders and files, and delete folders and files, for example.*
- *Making changes with a computer, however, could cause the order of the files to change when played back on the unit.*

Opening the BROWSE screen

In the following examples, we assume that an SD card is loaded and that **SD1** is selected as the current media. (see “Selecting media” on page 28)

When the playback area is **ALL** or **FOLDER** and the unit is playing back, in playback standby or stopped, press the **PITCH [BROWSE]** button while pressing the **SHIFT** button to open the **BROWSE** screen. (see “Playback area” on page 30)

The first time, the contents of the current folder on the current medium will be shown.

After the first time, the contents of the last shown medium or folder will be shown again.



Medium selected on the **BROWSE** screen

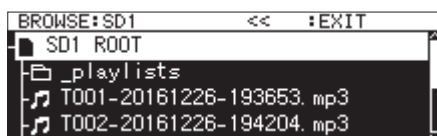

SD1 ROOT open on the **BROWSE** screen

NOTE

*To return to the media selection screen, on the **ROOT** level screen of the medium, press the **MENU [JOG]** or **◀◀ [A-B]** button.*

Navigating the BROWSE screen

On the **BROWSE** Screen, folders appear in a list in the same way files are shown on a computer.

When the **BROWSE** screen is open, use the **MULTI JOG** dial or **◀◀ [A-B]/▶▶ [INPUT]** buttons (or remote control **F3/F4** or **◀◀ [◀◀]/▶▶ [▶▶]** buttons) to select a folder or file for use.

- Press the **MULTI JOG** dial to open a folder or file pop-up menu. (see “Folder operations” on page 41), (see “File operations” on page 42)
- Turn the **MULTI JOG** dial or press the remote control **F3/F4** buttons to select a folder or file inside the same folder.
- Press the main unit **◀◀ [A-B]** button (or remote control **◀◀ [◀◀]** button) to move up one level. Press the main unit **▶▶ [INPUT]** button (or remote control **▶▶ [▶▶]** button) when a folder is selected on the second line or below to open that folder. You can also change levels when a folder is selected by turning the **MULTI JOG** dial to open the pop-up folder menu and select the **EXIT** or **ENTER** item. If the top line of the **BROWSE** screen is selected, the **EXIT** item that moves up one level will appear. If the second or later line is selected, the **ENTER** item that moves down one level will appear.
- Press the **HOME [INFO]** button (or remote control **F2** button) to return to the Home Screen.
- Press the **MENU [JOG]** button to return to the Menu Screen.
- When a folder or file is selected, press the main unit or remote control **PLAY** button to return to the Home Screen and play that folder or file.
If the playback area is **FOLDER**, the selected folder will become the current folder.
- When a folder or file is selected, press the **PAUSE [CALL]** button to return to the Home Screen and enter playback standby at the beginning of that folder or file.
If the playback area is **FOLDER**, the selected folder will become the current folder.
- When a folder or file is selected, press the **SHIFT** button to scroll file and folder names that are not shown completely.

5 – Working with Folders and Files (BROWSE screen)

Icons on the BROWSE screen

The icons that appear on the BROWSE Screen are as follows.

Media icons

The icon for the selected media ( /  / ) followed by the word "ROOT" will appear.

 icon: SD card

 icon: USB flash drive

 icon: FTP

Playlists

The file name appears after the  icon.

The  icon appears for the current playlist.

Plain folder

The file name appears after to the  icon.

The  icon appears for the current folder.

Audio file

The audio file name appears after the  icon.

Other files

The file name appears after to the  icon.

Folder operations

Select the desired folder on the BROWSE Screen and press the **MULTI JOG** dial to open the pop-up folder menu.



Turn the **MULTI JOG** dial to select the desired operation, and press the **MULTI JOG** dial to execute it as follows.

NOTE

When a protected SD card is loaded in the unit, the RENAME, DELETE and CREATE FOLDER items cannot be used. (see "SD card write-protection switches" on page 27)

ENTER / EXIT

Press the **MULTI JOG** dial when the ENTER item is shown to enter the selected folder and view its contents as a list.

Press the **MULTI JOG** dial when the EXIT item is shown to close the selected folder and move up one level.

RENAME

Open the RENAME screen where you can edit the name of the selected folder. (see "Editing folder and file names" on page 42)

DELETE

Delete the selected folder. (see "Deleting folders and files" on page 43)

UNDO

Immediately after deleting a folder or file, you can undo the deletion. (see "Undoing edit menu operations (UNDO)" on page 68)

COPY

Copy the selected folder. (see "Copying folders and files" on page 44)

MOVE

Move the selected folder. (see "Moving folders and files" on page 45)

SORT BY TIME

Reorder the folders and files shown by creation date.

SORT BY NAME

Reorder the folders and files shown by name.

SET TO CURRENT FOLDER

Set the selected folder as the current folder.

GO TO CURRENT FOLDER

Move to the current folder.

NOTE

- *The current folder:*
 - is the playback area when playback area is set to FOLDER
 - is where recorded files are saved
 - is where files are downloaded by download events when using the timer event function
- After creating a new folder for saving recorded files, follow the procedures above to make it the current folder.

CREATE FOLDER

Create a new folder. (see "Creating new folders" on page 44)

INFO

Open a pop-up with the information about the selected folder (total number of files, total time, total capacity and last change date).

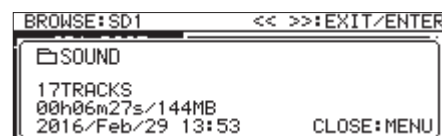

CANCEL

Close the folder menu.

NOTE

The following folder menu items will appear after a new folder is created using the CREATE FOLDER operation.

- RENAME
- DELETE
- UNDO
- MOVE

5 – Working with Folders and Files (BROWSE screen)

Deleting folders and files

You can delete folders and files from SD cards and USB flash drives.

Deleting a folder will also delete all the files it contains.

This is only possible when the playback mode is set to CONTINUE.

1. Select the folder or file that you want to delete, and open the folder/file pop-up menu.(see “Folder operations” on page 41), (see “File operations” on page 42)
2. Select the DELETE item, and press the **MULTI JOG** dial. The following pop-up message will appear.



When deleting a file

NOTE

Press the **MENU [JOG]** button to cancel deletion.

3. Press the **MULTI JOG** dial. A second confirmation pop-up message will appear.
4. Press and hold the **MULTI JOG** dial to delete the selected folder or file from the USB flash drive or SD card. A “Deleting Folder...” pop-up, for example, appears while the folder or file is being deleted. When deleting completes, the **BROWSE** screen opens.

NOTE

Immediately after deleting a folder or file, you can undo the deletion.(see “Undoing edit menu operations (UNDO)” on page 68)

Undoing folder or file deletion (UNDO)

Immediately after deleting a folder or file, you can undo the deletion.

Undoing (UNDO) is only possible when the playback mode is set to CONTINUE.

1. On the **BROWSE** screen, press the **MULTI JOG** dial to open a pop-up menu.(see “Folder operations” on page 41), (see “File operations” on page 42)
2. Select UNDO, and press the **MULTI JOG** dial to open a confirmation pop-up message.
3. Press the **MULTI JOG** dial to undo. A pop-up window appears while undoing. When undoing completes, the **BROWSE** screen opens.

NOTE

- Press the **MENU [JOG]** button to cancel undoing (UNDO).
- If there are no folders or files for which deletion can be undone, “Cannot UNDO” appears in a pop-up warning message.

Assigning files to a playlist

Files can be assigned to the current playlist at the desired positions.

1. Select the desired file, and press the **MULTI JOG** dial to open the pop-up file menu.(see “File operations” on page 42)
2. Select ASSIGN to PLAYLIST, and press the **MULTI JOG** dial to open the playlist assignment screen.

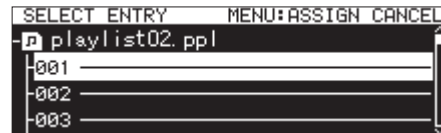

3. Turn the **MULTI JOG** dial to select the playlist entry position where you want to assign the file.
4. Press the **MULTI JOG** dial to open a pop-up menu.

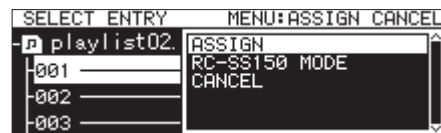

5. Select ASSIGN, and press the **MULTI JOG** dial to assign the file to the playlist.

NOTE

- A maximum of 100 entries can be assigned to a playlist. Flash playback, however, can only be used with 96 entries. See 6 – Editing Playlists page 46 for details.
- If you want to assign a file to a specific place in a playlist, see Assigning files to playlists page 50.

5 – Working with Folders and Files (BROWSE screen)

Creating new folders

1. Select the folder in which you want to create a new subfolder, and open the folder pop-up menu.(see “Folder operations” on page 41)
2. Select CREATE FOLDER, and open the CREATE FOLDER screen.



3. Input the folder name.
For details about how to input a folder name, see Editing textpage 59.
4. After you finish editing the folder name, select ENTER to confirm it.
A confirmation pop-up message will appear.

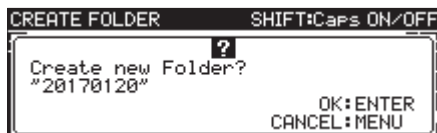

NOTE

During folder creation, press the MENU [JOG] button to cancel it.

5. Press the **MULTI JOG** dial to create the new folder.
A “Creating Folder...” pop-up appears while the new folder is being created.
After creation of the new folder completes, the BROWSE screen reopens and the new folder becomes the current folder.

NOTE

- The maximum number of folders that can be created on a single SD card or USB flash drive is 999.
- Media that are 2GB or less might not allow the creation of the above maximum number of folders inside the root folder due to file system limitations and use conditions.
- The initial folder name shown will be the year, month and day of the built-in clock.
(Example: 20150301)
- If this would be the same as the existing name, a three-digit number is added after the year, month and day provided by the built-in clock. (Example: 20150301_001)

Copying folders and files

1. Select the folder or file that you want to copy, and open the folder/file pop-up menu.(see “Folder operations” on page 41), (see “File operations” on page 42)
2. Select COPY, and press the **MULTI JOG** dial to open the copy destination folder selection screen.

NOTE

You cannot copy from FTP to FTP.

3. Move to the copy destination folder.
 - If it is the first time copying, the media selection screen will open. Select the medium that contains the copy destination folder and then move to that folder.

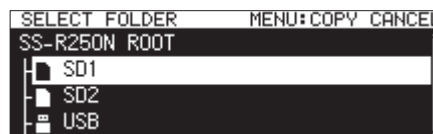

- If it is the second or later time, the last shown copy destination folder selection screen will reopen.

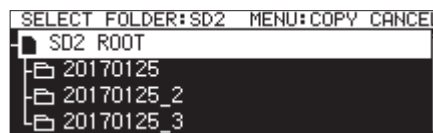

NOTE

- During copy destination folder selection, SELECT FOLDER blinks on the BROWSE screen.
 - While selecting a copy destination folder, press the MENU [JOG] button to open a CANCEL COPY? confirmation pop-up message. Press the **MULTI JOG** dial to close the copy destination folder selection screen and return to the BROWSE screen.
 - While the copy destination is selected, select the CANCEL item from the pop-up menu, and press the **MULTI JOG** dial to close the copy destination folder selection screen and return to the BROWSE screen.
4. Select the copy destination folder, and open the folder pop-up menu.

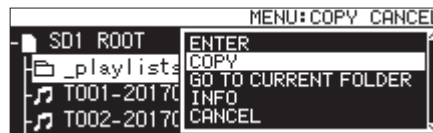

5. Select COPY, and press the **MULTI JOG** dial to open a confirmation pop-up message.

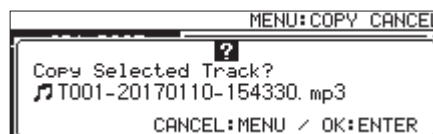

5 – Working with Folders and Files (BROWSE screen)

6. Press the **MULTI JOG** dial to copy the item.
Press the **MENU [JOG]** button to cancel copying or change the copy destination.

NOTE

*If a folder or file with the same name already exists in the copy destination, a **Cannot Copy Folder or Cannot Copy File** pop-up message will open.*

To change the name of the copied folder or file, press the **MULTI JOG** dial.

*For details about how to input text, see **Editing text** page 59. Press the **MENU [JOG]** button to cancel copying.*

7. A “**COPYING Track...**” pop-up appears while the item is being copied.
When copying completes, the pop-up disappears and the **BROWSE** screen reopens.

Moving folders and files

1. Select the folder or file that you want to move, and open the folder/file pop-up menu. (see “Folder operations” on page 41), (see “File operations” on page 42)
2. Select **MOVE**, and press the **MULTI JOG** dial to open the move destination folder selection screen.

NOTE

You cannot move from FTP to FTP.

3. Move to the selected destination folder.
 - If it is the first time moving, the media selection screen will open. Select the folder on the medium that contains the destination folder.
 - If it is the second or later time, the last shown move destination folder selection screen will reopen.

NOTE

- *During move destination folder selection, **SELECT FOLDER** blinks on the **BROWSE** screen.*
- *While selecting a move destination folder, press the **MENU [JOG]** button to open a **CANCEL MOVE?** confirmation pop-up message. Press the **MULTI JOG** dial to close the move destination folder selection screen and return to the **BROWSE** screen.*
- *While the move destination is selected, select **CANCEL** from the pop-up menu, and press the **MULTI JOG** dial to close the move destination folder selection screen and return to the **BROWSE** screen.*

4. Select the folder or file that you want to move it to, and open the folder/file pop-up menu.
5. Select **MOVE**, and press the **MULTI JOG** dial to open a confirmation pop-up message.
6. Press the **MULTI JOG** dial to move the item.
Press the **MENU [JOG]** button to cancel moving or change the move destination.

NOTE

*If a folder or file with the same name already exists in the copy destination, a **Cannot Move Folder or Cannot Move File** pop-up message will open.*

*To change the name of the moved folder or file, press the **MULTI JOG** dial.*

*For details about how to input text, see **Editing text** page 59. Press the **MENU [JOG]** button to cancel moving.*

7. A “**MOVING Track...**” pop-up appears while the item is being moved.
When moving completes, the pop-up disappears and the **BROWSE** screen reopens.

6 – Editing Playlists

Playlist editing overview

The first time that any SD card or USB flash drive is loaded in the unit, one empty playlist will be created on it automatically. You can also create new playlists.

Playback units in the playlist are called “entries”.

A maximum of 100 entries can be assigned to a playlist.

Only files on the medium that contains the created playlist can be assigned as entries.

To assign files from other media to a playlist, copy them to the current medium first.

An entry can be assigned and removed from a playlist even when it is being played back.

The entry that is currently being played, however, cannot be changed.

Opening the playlist screen

Opening the playlist screen from the BROWSE screen

You can view the playlist screen from the BROWSE screen. If the medium was formatted by this unit, a `playlist01.ppl` playlist will automatically be created inside the `_playlists` folder in the first level of the ROOT folder. You can also create new playlists inside the `_playlists` folder. (see “Creating new playlists” on page 49)

The following operation examples use `playlist01.ppl`, which is automatically created after formatting.

1. Press the **PITCH [BROWSE]** button while pressing the **SHIFT** button to open the BROWSE screen.
2. When the ROOT folder is selected, turn the **MULTI JOG** dial to select the `_playlists` folder.

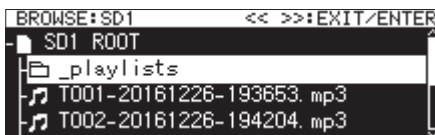

3. Press the **MULTI JOG** dial to open a pop-up menu.



4. Select **ENTER**, and press the **MULTI JOG** dial. This opens the `_playlists` folder where the `playlist01.ppl` playlist that was automatically created appears.

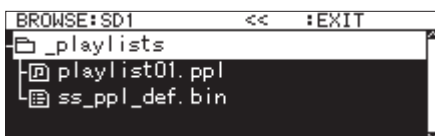

5. Select `playlist01.ppl`, and press the **MULTI JOG** dial to open a pop-up menu.

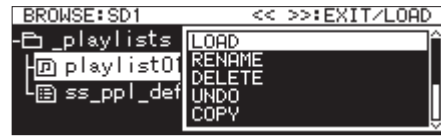

6. Select **ENTER** (if the current playlist is `playlist01.ppl`) or **LOAD** (if the current playlist is not `playlist01.ppl`), and press the **MULTI JOG** dial to show the files that have been assigned to `playlist01.ppl`. If nothing has been assigned yet, 100 blank entries will appear.

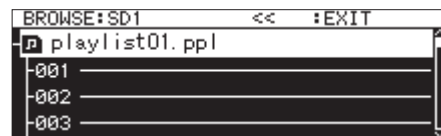

NOTE

On this unit, `playlist01.ppl` will be the current playlist at first. After other playlists have been created, the playlist opened last becomes the current playlist.

Opening the current playlist screen from the menu page

Select **PLAYLIST EDIT** on the **PLAYLIST** page to open the entry list screen for the current playlist.

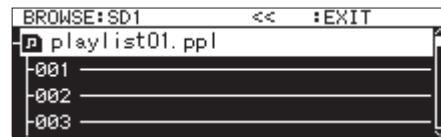

Assigning files to a playlist

Files can be assigned to playlists.

See Assigning files to playlists page 50 for details.

Playlist menu operations

When a playlist is selected, press the **MULTI JOG** dial to open the playlist menu.

This is a menu of operations that affect playlists.

NOTE

*If the **Playlists** folder or current playlist is selected when the playlist menu pop-up is opened, the **RENAME** and **DELETE** items will not be shown.*

LOAD

Load the selected playlist as the current playlist and open the entry list screen for the playlist. (see “Setting the current playlist” on page 47)

ENTER

Open the entry list screen for the selected current playlist.

EXIT

Move up one screen level.

If the entry list screen is open, move to the **_playlists** folder.

RENAME

Change the name of the playlist. (see “Editing playlist names” on page 48)

SAVE AS

Save the current playlist in the same **_playlists** folder with a different name. (see “Saving the current playlist with a different name” on page 48)

DELETE

Delete the playlist. (see “Deleting playlists” on page 48)

COPY

Copy the selected playlist file. (see “Copying folders and files” on page 44)

MOVE

Move the selected playlist file. (see “Moving folders and files” on page 45)

CREATE PLAYLIST

Create a new playlist. (see “Creating new playlists” on page 49)

NOTE

*When a protected SD card is loaded in the unit, the **RENAME**, **DELETE** and **CREATE PLAYLIST** items cannot be used. (see “SD card write-protection switches” on page 27)*

INFO

Shows playlist information.

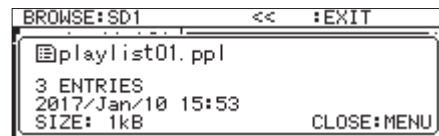

CANCEL

Do no operation on the selected playlist and return to the playlist menu.

NOTE

*The following operations are only possible when the **PLAY MODE** is set to **CONTINUE**.*

- **RENAME**, **DELETE**, **UNDO**, **COPY**, **MOVE**, **SORT BY TIME**, **SORT BY NAME**

Setting the current playlist

1. Select the playlist you want to set as the current playlist, and open the playlist pop-up menu. (see “Playlist menu operations” on page 47)
2. Select **LOAD**, and press the **MULTI JOG** dial. A confirmation pop-up message appears.



NOTE

*Press the **MENU [JOG]** button to cancel playlist loading.*

3. Press the **MULTI JOG** dial again to load the selected playlist as the current playlist. While loading, “LOADING PLAYLIST...” appears in a pop-up.



When loading completes, the entry list screen for the current playlist opens.

6 – Editing Playlists

Editing playlist names

1. Select the playlist with the name you want to edit, and open the playlist pop-up menu.(see “Playlist menu operations” on page 47)
2. Select RENAME, and open the RENAME FILE screen.



3. Edit the playlist name.
For details about how to edit the playlist name, see Editing textpage 59.
4. After you finish editing the playlist name, select ENTER and press the **MULTI JOG** dial to confirm the name.
A RENAMING . . . pop-up appears while the playlist name is being changed.



After renaming the playlist completes, the BROWSE screen reopens.

Saving the current playlist with a different name

1. Select the playlist that is set as current, and open the playlist pop-up menu.(see “Playlist menu operations” on page 47)
2. Select SAVE AS, and open the PLAYLIST NAME screen.

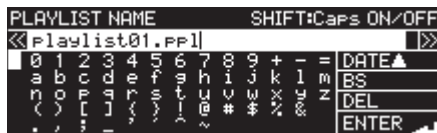

3. Edit the playlist name, and save it.
For details about how to edit the playlist name, see Editing textpage 59.
4. After you finish editing the playlist name, select ENTER and press the **MULTI JOG** dial to confirm the name.
A Saving File . . . pop-up appears while the playlist name is being saved.



When saving with a different name completes, the BROWSE screen opens.

Deleting playlists

NOTE

The current playlist cannot be deleted.

1. Select the playlist that you want to delete, and open the playlist pop-up menu.(see “Playlist menu operations” on page 47)
2. Select DELETE, and press the **MULTI JOG** dial.
A confirmation pop-up message appears.



NOTE

Press the MENU [JOG] button to cancel playlist deletion.

3. Press the **MULTI JOG** dial again to open a second confirmation pop-up message.



4. Press and hold the **MULTI JOG** dial to delete the selected playlist.
A DELETING FILE . . . pop-up appears while the playlist name is being deleted.

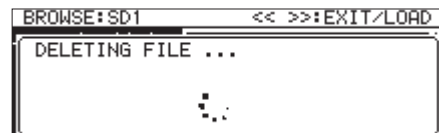

When deleting completes, the BROWSE screen opens.

NOTE

When a playlist is deleted, the audio files themselves are not deleted. Only the information added to function as a playlist is deleted

If you want to delete the audio files themselves, see Deleting folders and filespage 43.

Creating new playlists

New playlists can be created inside the `_playlists` folder.

1. On the **BROWSE** screen, select the `_playlists` folder or a playlist, and open the playlist pop-up menu.(see “Playlist menu operations” on page 47)
2. Select **CREATE PLAYLIST**, and open the **CREATE PLAYLIST** screen.



3. Input the desired playlist name.
For details about how to input playlist names, see Editing textpage 59.
4. After you finish inputting the playlist name, select **Enter** and press the **MULTI JOG** dial to confirm the name.
A confirmation pop-up message appears.



NOTE

Press the **MENU [JOG]** button to cancel playlist creation.

5. Press the **MULTI JOG** dial to create the new playlist.
A “CREATING...” pop-up appears while the playlist is being created.

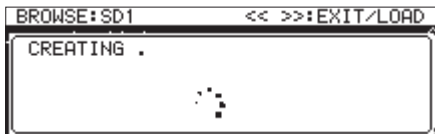

After creation completes, the **BROWSE** screen reopens.

Playlist entry menu operations

When a file that has been assigned to a playlist is selected, press the **MULTI JOG** dial to open the playlist entry menu.

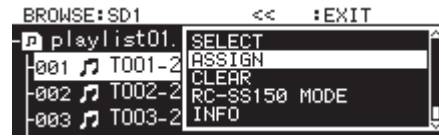

This is a menu of operations that affect files that have been assigned to playlists.

SELECT

Set the file that has been assigned to the selected playlist as the current track, and return to the Home Screen.

ASSIGN

Assign the file to the playlist at the selected position.

If the selected position already has an assigned file, it will be replaced.(see “Assigning files to playlists” on page 50)

CLEAR

Remove the file assigned to the playlist at the selected position. (see “Clearing file assignments from playlists” on page 50)

After clearing the assignment, the entry will become empty.

RC-SS150 MODE

Change the list style playlist assignment screen to a screen for use with a TASCAM RC-SS150.

LIST MODE

Change the playlist assignment screen for use with a TASCAM RC-SS150 to a list style screen.

INFO

Show information about the files assigned to the playlist.

NOTE

*When a protected SD card is loaded in the unit, the **ASSIGN** and **CLEAR** items cannot be used.(see “SD card write-protection switches” on page 27)*

CANCEL

Do no operation on the selected playlist file and return to the playlist file menu.

6 – Editing Playlists

Assigning files to playlists

Use **ASSIGN** in the playlist entry menu to assign files to a playlist.

1. Select the entry position in the playlist that you want to assign, and open the playlist entry pop-up menu. (see “Playlist entry menu operations” on page 49)
2. Select **ASSIGN**, and open the **SELECT ENTRY** screen.

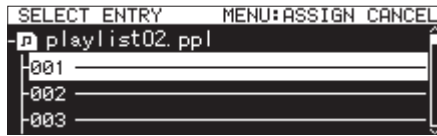

3. Select the file you want to assign, and press the **MULTI JOG** dial to open the pop-up file menu.

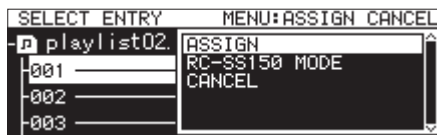

4. Select **ASSIGN**, and press the **MULTI JOG** dial to assign the file to the playlist.

NOTE

- A maximum of 100 entries can be assigned to a playlist. Flash playback, however, can only be used with 96 entries.
- For the procedures for assigning specific files to playlists, see *Assigning files to a playlist* page 43.

Clearing file assignments from playlists

To clear files assigned to playlists, use **CLEAR** in the playlist file menu.

This operation clears file assignments in playlists. The files themselves are not deleted.

1. Select the track in the playlist that you want to clear, and open the playlist entry pop-up menu. (see “Playlist entry menu operations” on page 49)
2. Select **CLEAR**, and press the **MULTI JOG** dial. A confirmation pop-up message appears.



NOTE

Press the **MENU [JOG]** button to cancel assignment clearing.

3. Press and hold the **MULTI JOG** dial to clear the assignment.
4. After clearing an assignment completes, the **BROWSE** screen reopens. After clearing the assignment, the entry will become empty.

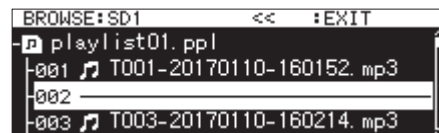

NOTE

If you want to delete the audio files themselves, see *Deleting folders and files* page 43.

RC-SS150 MODE playlist assignment screen

This screen allows you to make playlists assignments following the layout of a TASCAM RC-SS150 (sold separately).

Turn the **MULTI JOG** dial to select an entry or page.

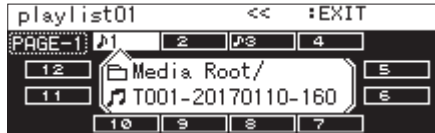

When an entry is selected, press the **MULTI JOG** dial to open the playlist entry menu pop-up and use the desired function. Operation procedures are the same as when using the list format.



Press the **MULTI JOG** dial when the page item at the top left of the screen is selected to open a screen where you can change the page that is edited.



Turn the **MULTI JOG** dial to change the page.

The setting range is 1–8.

Press the **MULTI JOG** dial to confirm the change and return to the RC-SS150 MODE playlist assignment screen.

7 – Recording

This unit can record to SD cards and USB flash drives in the following formats.

MP3

44.1/48kHz sampling frequency, 64/128/192/256/320kbps

WAV/BWF

44.1/48/96kHz sampling frequency, 16/24-bit

The following explanations assume that a recordable SD card or USB flash drive has been loaded, necessary connections have been completed and the unit is on.

NOTE

- *The maximum numbers of tracks that can be recorded and folders that can be created are as follows. (Same for both SD cards and USB flash drives)*
 - Number of tracks: 999 maximum per folder
 - Number of folders: 3000 maximum on each medium
- *Media that are 2GB or less might not allow the recording of 999 tracks inside the root folder due to file system limitations. A maximum of 999 tracks can be recorded in subfolders. (This may differ according to use conditions.)*
- *When a protected SD card is loaded in the unit, recording is not possible. (see "SD card write-protection switches" on page 27)*

Unexpected power interruptions

The unit has a protection function to prevent the deletion of all recording tracks if an unexpected power interruption occurs while recording to an SD card or USB flash drive. Data up to 25 seconds before the interruption will be protected.

CAUTION

- *The unit has a protection function, but all the files on the SD card or USB flash drive could be damaged or deleted due to other factors, including the characteristics of the medium, power interruption while writing to a system area or removal of the medium from the unit. For these reasons, as much as possible avoid power interruptions during recording and playback.*
- *This function was not designed for use with an external timer to turn off the power during recording, for example.*

Selecting the input source

Select one of the following input (recording) sources.

Option	Meaning
ANALOG UNBALANCED (default)	Input from ANALOG IN (UNBALANCED) L/R jacks
ANALOG BALANCED	Input from ANALOG MIC/LINE IN (BALANCED) L/R jacks
DIGITAL COAXIAL	Input from SPDIF IN jack
DIGITAL XLR	Input from AES/EBU IN jack
IF-DA2 (DANTE) (appears only if IF-DA2 installed)	Input from IF-DA2 Dante interface card

Follow the procedures below to select the input source.

NOTE

The input source cannot be changed during recording.

Selecting from the Home Screen

1. Press the ►► [INPUT] button while pressing the SHIFT button to open the input source setting pop-up window. The input source setting window shows the current input.



2. When the input source setting window is open, turn the MULTI JOG dial to select the input source, and press the MULTI JOG dial to change it.

Selecting from the Menu Screen

1. Select INPUT SELECT on the REC 1 page to open the INPUT SELECT screen. (see "Menu operation procedures" on page 22)



2. Select the input source.
Options: ANALOG UNBALANCED (default), ANALOG BALANCED, DIGITAL COAXIAL, DIGITAL XLR, IF-DA2 (DANTE) (shown only if IF-DA2 installed)

NOTE

If the input source is DIGITAL COAXIAL, DIGITAL XLR or IF-DA2 (DANTE) (shown only if IF-DA2 installed), but it is unlocked, "" will appear at the end of the option.*

3. Confirm the setting and return to the Menu Screen.

Input source display

Confirm the currently selected input source by following the procedures in “Selecting the input source” above or checking the input setting status on the recording screen.



Input source information display

NOTE

If DIGITAL XLR, DIGITAL COAXIAL or IF-DA2 (DANTE) (only when IF-DA2 card installed) is selected, pop-up messages will appear under the following conditions.

- The unit is not digitally locked to the input source (DIN UNLOCK will appear).
- The input source is not audio (DIN Not Audio will appear).
- If the sampling frequency set with the SAMPLE item on the REC 3 page differs from the input source, FS UNMATCH will appear. If the sampling rate converter is active, however, recording will be possible even if the sampling frequency is different. (see “Using the sampling rate converter” on page 60)

Setting left/right channel inputs separately

Left and right channel input settings can be made separately on this unit.

The screens where they can be set separately are as follows.

- BALANCED INPUT GAIN screen (see “Setting mic/line input sensitivity” on page 54)
- INPUT LEVEL screen (see “Adjusting input signal levels” on page 54)
- PHANTOM POWER screen (see “Setting phantom power” on page 55)
- MIC AGC screen (see “Setting automatic gain control for mic inputs” on page 55)
- DYNAMICS screen (see “Using the dynamics function” on page 56)
- LOW CUT screen (see “Setting the low-cut filter” on page 56)

1. Select the REC SET LINK item on the REC 1 page to open the REC SET LINK screen. (see “Menu operation procedures” on page 22)



2. Select the left/right channel setting method.

Option	Meaning
OFF	Left and right channels input settings are made separately.
ON (default)	The left and right channel input settings are linked.

NOTE

When the left and right channel settings are unlinked, if the REC SET LINK screen LINK item is changed to ON, the right channel settings will change to match the left channel settings. If the REC SET LINK screen LINK item is reset to OFF, the right channel will retain the same settings as the left channel.

3. Confirm the setting and return to the Menu Screen.

7 – Recording

Setting mic/line input sensitivity

Before starting recording, input gains should be adjusted to prevent recorded sounds or signals from being distorted due to excessive input levels and to prevent them from being so low that they are below the noise floor.

NOTE

This item will not appear when the input source is set to anything other than ANALOG BALANCED. (see “Selecting the input source” on page 52)

1. Select BAL. INPUT GAIN on the REC 1 page to open the BALANCED INPUT GAIN screen. (see “Menu operation procedures” on page 22)

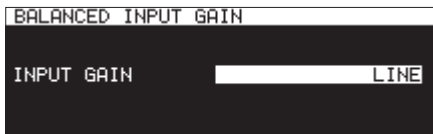

2. Set the mic input sensitivity.

Option	Meaning
LINE (default)	Use when connecting the line output jacks of external devices to this unit's MIC/LINE IN (BALANCED) L/R jacks.
MIC-LOW	Use when mics are connected to the MIC/LINE IN (BALANCED) L/R jacks.
MIC-HIGH	

NOTE

When REC SET LINK is set to OFF on the REC 1 page, the levels of the left and right channel inputs are adjusted separately. (see “Setting left/right channel inputs separately” on page 53)

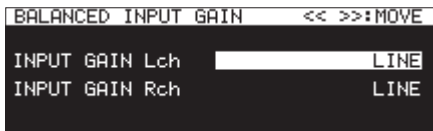

3. Confirm the setting and return to the Menu Screen.

Adjusting input signal levels

Use the following procedures to adjust input signal levels.

1. Select INPUT LEVEL on the REC 1 page to open the INPUT LEVEL screen. (see “Menu operation procedures” on page 22)



INPUT LEVEL screen when adjusting line level

2. Adjust the input signal levels.

LINE LEVEL (when BALANCE INPUT GAIN screen set to LINE)

Options: -inf, -54dB, -48dB, -42dB, -36dB, -30dB, -24dB, -20dB, -16dB, -12dB, -10dB, -8dB, -6dB - 0.0dB (default) - +6.0dB (0.5dB increments), +7.0dB - +18.0dB (1.0dB increments)

MIC LEVEL (when BALANCE INPUT GAIN screen setting is MIC-LOW or MIC-HIGH)

Options: MUTE (minimum), -4.0dB - 0.0dB (default) - +6.0dB (0.5dB increments), +7.0dB - +31.0dB (1.0dB increments), +31.5dB

DIGITAL LEVEL (INPUT SELECT screen set to DIGITAL COAXIAL, DIGITAL XLR or IF-DA2 (DANTE))

Options: -6.0dB - 0.0dB (default value), 0.1dB increments) - +6.0dB

NOTE

When REC SET LINK is set to OFF on the REC 1 page, the levels of the left and right channel inputs are adjusted separately. (see “Setting left/right channel inputs separately” on page 53)

3. Confirm the setting and return to the Menu Screen.

NOTE

You can use the level meters shown on the INPUT LEVEL screen to check input levels as you adjust them. Set the level so that they are as high as possible without exceeding the level meter peak levels.

Setting phantom power

Phantom power can be turned on when an external mic that requires it is connected to a **MIC/LINE IN (BALANCED) L/R** jack.

1. Select **MIC PHANTOM** on the **REC 1** page to open the **PHANTOM POWER** screen. (see “Menu operation procedures” on page 22)

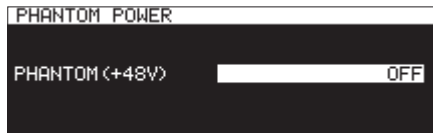

2. Turn phantom power on or off.

Options: OFF (default), ON

NOTE

- When phantom power is on, the **48V** icon appears in the recording function activation status area on the recording screen.
The unit will actually output phantom power when the **INPUT SELECT** screen is set to **ANALOG BALANCED**, or the **BAL. INPUT GAIN** screen is set to **MIC-LOW** or **MIC-HIGH**. When phantom power is actually turned on, a “Phantom Power ON?” message will appear.
 - When **REC SET LINK** is set to **OFF** on the **REC 1** page, the levels of the left and right channel inputs are adjusted separately. (see “Setting left/right channel inputs separately” on page 53)
3. Confirm the setting and return to the Menu Screen.

Phantom power (48V) will be turned on for the **MIC/LINE IN (BALANCED) L/R** jacks and supplied to connected mics.

CAUTION

- Before making connections, turn this unit and all equipment to be connected off (standby).
- Confirm that phantom power is **OFF** before connecting a line level device to a **MIC/LINE IN (BALANCED) L/R** jack. If you connect a line level device while phantom power is being supplied, that device and this unit could be damaged.
- Do not connect or disconnect mics with the **MIC/LINE IN (BALANCED) L/R** jacks while phantom power is on. Doing so could cause a loud noise and might damage the equipment.
- Turn phantom power **ON** only when using a condenser microphone that requires phantom power. Turning phantom power on when a dynamic mic or other mic that does not require it is connected could damage this unit and connected equipment.
- When using condenser mics that require phantom power and dynamic mics together, be sure to use balanced dynamic mics. Unbalanced dynamic mics cannot be used when phantom power is enabled.
- Supplying phantom power to some ribbon mics will break them. If you are unsure, do not supply phantom power to a ribbon mic.
- Some condenser microphones will not operate when phantom power is set to 48V.

Setting automatic gain control for mic inputs

When the **MIC AGC** (automatic gain control during mic input) function is on, mic input levels will be adjusted automatically in response to the input audio.

Using this function, the recording level is automatically increased when the input sound is too quiet or decreased when it is too loud. This function is useful for recording meetings, for example.

1. Select **MIC AGC** on the **REC 2** page to open the **MIC AGC** screen. (see “Menu operation procedures” on page 22)



2. Turn the **MIC AGC** function on or off.

Options: OFF (default), ON

NOTE

- When the automatic gain control function is on, the **AGC** icon appears in the recording function activation status area on the recording screen.
 - When **REC SET LINK** is set to **OFF** on the **REC 1** page, the levels of the left and right channel inputs are adjusted separately. (see “Setting left/right channel inputs separately” on page 53)
3. Confirm the setting and return to the Menu Screen.

7 – Recording

Using the dynamics function

By turning the dynamics function on, you can apply this unit's limiter or compressor to recording sources and prevent input signal levels from overloading during recording.

1. Select **DYNAMICS** on the **REC 2** page to open the **DYNAMICS** screen.(see “Menu operation procedures” on page 22)



2. Set the input signal dynamics function.

Option	Meaning
OFF (default)	Do not use the dynamics function.
LIMITER	This applies the limiter. This suppresses distortion of sound due to sudden excessive input.
COMP_SOFT	This applies light compression. This setting is good for music.
COMP_HARD	This applies heavy compression. This setting is good for recording meetings and similar situations.

NOTE

- When the dynamics function is on, the **LIMITER**, **COMP.SOFT** or **COMP.HARD** icon appears in the recording function activation status area on the recording screen.
 - Distortion of sounds may occur when signals that are very loud are input even when the limiter is activated. In such a case, lower the recording level or increase the distance between the mic and the sound source.
 - Compressors are effects that suppress peak sounds and make audio easier to hear overall by raising and lowering levels for a more even volume.
 - When **REC SET LINK** is set to **OFF** on the **REC 1** page, the levels of the left and right channel inputs are adjusted separately. In this case, the left channel setting will be shown on the Home Screen when recording or in recording standby. If the left channel setting is **OFF**, but the right channel setting is not **OFF**, however, the right channel setting will be shown on the Home Screen.(see “Setting left/right channel inputs separately” on page 53)
3. Confirm the setting and return to the Menu Screen.

Setting the low-cut filter

The low-cut filter can reduce bothersome noise, such as from wind, air-conditioners and projectors.

1. Select **LOW CUT** on the **REC 2** page to open the **LOW CUT** screen.(see “Menu operation procedures” on page 22)



2. Set the cutoff frequency of the low-cut filter used during input.

Options: OFF (default), 40Hz, 80Hz, 120Hz, 180Hz, 220Hz

NOTE

- When the low-cut filter function is on, the **LOW CUT** icon appears in the recording function activation status area on the recording screen.
 - When **REC SET LINK** is set to **OFF** on the **REC 1** page, the levels of the left and right channel inputs are adjusted separately.
3. Confirm the setting and return to the Menu Screen.

Setting the recording file format

To set the recording file format, use the REC FORMAT, BACKUP/RELAY MEDIA, WAV SETTING, MP3 BITRATE and STEREO/MONO items on the REC 3 page. (see “Menu operation procedures” on page 22)

Making recording format settings

Select REC FORMAT, and open the REC FORMAT screen. (see “Menu operation procedures” on page 22)

Set the sampling frequency and file format combination for recording.

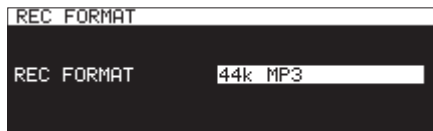

Option	Recording contents	
	Sampling frequency File format	Optional functions
44k WAV	44.1kHz WAV	None
44k MP3 (default)	44.1kHz MP3	None
44k WAV16+MP3	44.1kHz WAV (16-bit) + MP3	Dual format recording function
44k WAV (BACKUP)	44.1kHz WAV	Backup recording function
44k MP3 (BACKUP)	44.1kHz MP3	
44k WAV (RELAY)	44.1kHz WAV	Relay recording function
44k MP3 (RELAY)	44.1kHz MP3	
44k WAV16+MP3 (RELAY)	44.1kHz WAV (16-bit) + MP3	Relay/dual format recording functions
48k WAV	48kHz WAV	None
48k MP3	48kHz MP3	None
48k WAV16+MP3	48kHz WAV (16-bit) + MP3	Dual format recording function
48k WAV (BACKUP)	48kHz WAV	Backup recording function
48k MP3 (BACKUP)	48kHz MP3	
48k WAV (RELAY)	48kHz WAV	Relay recording function
48k MP3 (RELAY)	48kHz MP3	
48k WAV16+MP3 (RELAY)	48kHz WAV (16-bit) + MP3	Relay/dual format recording functions
96k WAV	96kHz WAV	None

Recording option functions

● Simultaneous recording of files in two formats (dual format recording)

When an option with “WAV16+MP3” is selected, both WAV 16bit (BWF) and MP3 file formats will be simultaneously recorded.

● Simultaneous recording to multiple media (backup recording)

When an option with “(BACKUP)” is selected, simultaneous recording to multiple media is enabled.

By using this function, unplanned recording interruptions caused by media problems can be avoided.

● Recording to multiple media in succession (relay recording)

When an option with “(RELAY)” is selected, recording to multiple media in succession is enabled.

Continuous recording for long periods of time is possible using this function.

● When relay recording completes, the media used at the beginning of recording is reset as the current media.

● Files created using relay recording have an “R” added to the beginnings of their names, for example “R001_20170101-123456.wav”.

NOTE

● When relay recording is enabled, an icon like showing the current media and the next relay recording media appears at the top right of the recording screen.

● When the dual format recording function is selected, an icon like showing both recording formats appears at the top right of the recording screen.

● When using dual format recording, the bit length setting for WAV files is fixed at 16-bit.

● If the BIT LENGTH was set to 24bit on the WAV SETTING screen, it will automatically be changed to 16bit. (see “WAV file settings” on page 58)

Setting the second medium for backup and relay recording

Select BACKUP/RELAY MEDIA, and open the BACKUP/RELAY MEDIA screen. (see “Menu operation procedures” on page 22)

Set the secondary media to be used for backup and relay recording when each medium is current.

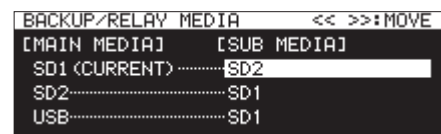

● Select the SD1 item, and set the second medium (SUB MEDIA) to be used for backup and relay recording when it is the current medium (MAIN MEDIA).

Options: SD2 (default), USB

● Select the SD2 item, and set the second medium (SUB MEDIA) to be used for backup and relay recording when it is the current medium (MAIN MEDIA).

Options: SD1 (default), USB

● Select the USB item, and set the second medium (SUB MEDIA) to be used for backup and relay recording when it is the current medium (MAIN MEDIA).

Options: SD1 (default), SD2

NOTE

● The medium with (CURRENT) after its [MAIN MEDIA] name is the current medium now.

● A folder with the same file path as the current media will be created on the secondary media and used for backup and relay recording.

7 – Recording

WAV file settings

Select **WAV SETTING**, and open the **WAV SETTING** screen.(see “Menu operation procedures” on page 22)



- Select **FORMAT TYPE**, and set the file format to use for WAV recording.

Options: WAV (default), BWF

- Select **BIT LENGTH**, and set the bit length to use for WAV recording.

Options: 16bit (default), 24bit

NOTE

When dual format recording is on, 24bit cannot be selected.

MP3 file bit rate setting

Select **MP3 BITRATE**, and open the **MP3 BITRATE** screen.(see “Menu operation procedures” on page 22)

Set the bit rate to use for MP3 format recording.



Options: MP3-64kbps, MP3-128kbps, MP3-192kbps (default), MP3-256kbps, MP3-320kbps

Recording input channel settings

Select **STEREO/MONO**, and open the **STEREO/MONO** screen.(see “Menu operation procedures” on page 22)

Set the input channel to record.



Option	Meaning
STEREO (default)	Save the left and right channel input sounds to a stereo file.
MONO (MIX)	Mix the left and right channel input sounds and save the mix as a mono file.
MONO (2ch)	Save the left and right channel input sounds to two separate mono files.

Monitoring input signals

Press the **RECORD [TRACK INC]** button (or remote control **RECORD** button) to put the unit in recording standby. The **RECORD [TRACK INC]** and **PAUSE [CALL]** buttons will light and the input signals will be output from this unit's various outputs (headphones, analog balanced and unbalanced jacks, and digital connectors). The meters at the top of the Home Screen will also show input levels.

Press the **STOP** button (or remote control **STOP** button) to end recording standby.

TIP

If you do not plan to record, but just want to monitor the input signals, without setting the current media, press the **RECORD [TRACK INC]** button (or remote control **RECORD** button). The **RECORD [TRACK INC]** button will blink. To stop monitoring the input signals, press the **STOP** button (or remote control **STOP** button).

Basic recording operations

Make the following settings (input source selection, recording file format, sampling rate conversion on/off, input level adjustments) before recording.

Entering recording standby from a stopped state:

Press the **RECORD [TRACK INC]** button (or remote control **RECORD** button). (The **RECORD [TRACK INC]** and **PAUSE [CALL]** buttons light.

Starting recording from recording standby:

Press the main unit or remote control **PLAY** button.

Pausing recording:

Press the **PAUSE [CALL]** button (or remote control **F1** button).

Stopping recording:

Press the main unit or remote control **STOP** button.

Recording stops, recording data are written and audio files are created.

NOTE

- On the **FILE NAME** screen, you can set the name that is automatically given to audio files when they are created.(see “Setting the recording file format” on page 57)
- The maximum file size for each track is 2 GB.
- Recorded tracks are created in the current folder.(see “Folder operations” on page 41)

CAUTION

“WRITING FILE...” appears while recording data is being written to the current media. During this time, do not move the unit, turn it off, or remove the current media. Doing so could prevent the recording data from being properly written.

Setting the file name format

You can select the format of names given to files automatically during recording.

1. Select the **FILE NAME** item on the **REC 4** page to open the **FILE NAME** screen. (see “Menu operation procedures” on page 22)

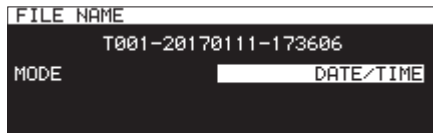

2. Set the file name format.

Option	Meaning
DATE/TIME (default)	The date and time of the unit's built in clock are used for the file name.
USER01	The text set by the user (8 characters) is used for the file name.
USER02	
USER03	

3. If you selected **DATE/TIME** or **USER01** – **USER02** and do not want to edit the file name, press the **MULTI JOG** dial to return to the menu.

If you selected **USER01** – **USER03** and you want to edit the file name, press the **[INPUT]** button to open the **RENAME** screen.

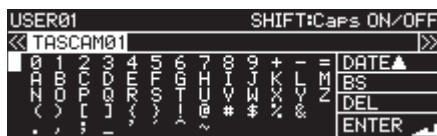

4. Edit the file name.
5. After you finish editing, turn the **MULTI JOG** dial and select **ENTER**. Press the **MULTI JOG** dial to confirm the edited text and return to the **FILE NAME** screen.
6. Press the **MULTI JOG** dial again to return to the menu screen.

Editing text

Use these operations to edit text.

Changing the cursor (editing point) position

Press the **[A-B]** and **[INPUT]** buttons.

Changing the character input:

Turn the **MULTI JOG** dial.

Inputting the selected character at the cursor (editing) position:

Press the **MULTI JOG** dial.

Leaving a single space open:

Turn the **MULTI JOG** dial to select a blank space at the left end of any row, and press the **MULTI JOG** dial.

Deleting a character:

Turn the **MULTI JOG** dial to select **DEL** (to delete a character to the right of the cursor) or **BS** (to delete a character to the left of the cursor), and press the **MULTI JOG** dial.

Deleting all characters to the right of the cursor:

Turn the **MULTI JOG** dial to select **DEL**, and press and hold the **MULTI JOG** dial.

Deleting all characters to the left of the cursor:

Turn the **MULTI JOG** dial to select **BS**, and press and hold the **MULTI JOG** dial.

Switching between upper and lower case:

Press the **SHIFT** button.

Canceling edits:

Press the **MENU [JOG]** button.

Inputting the date.

Turn the **MULTI JOG** dial to select **DATE**.

Press the **MULTI JOG** dial to input the date and time of the built-in clock in **yyyy-mm-dd** format.

On the **RENAME FOLDER** screen, if a folder with the same name already exists, an underscore (**_**) followed by a number that has not already been used will be added to the end of the name.

CAUTION

- You can connect a USB flash drive or SD card to a computer and edit file names from the computer. Doing so, however, could cause the order of the files to change when played back on the unit.
- On a text input screen, characters other than half-width (normal) English letters, numerals and symbols will not be shown. If text includes characters other than half-width English letters, numerals and symbols, opening a text input screen will delete them.
- The following symbols and punctuation marks cannot be used in text.

¥ / : * ? " ' < > |

NOTE

You can also use a USB keyboard to edit characters. (see “Using the keyboard to input names and values” on page 85)

Character input limit

The white background in the character field indicates the maximum number of characters. The gray background shows characters in excess of the maximum number. These will be discarded when you select **Enter** and confirm the input text.

7 – Recording

Applying dithering to recording

When recording in 16-bit WAV format the dynamic range is about 96.3 dB.

You can set how the unit processes the quiet sounds above the 16-bit range that are lost (quantization noise) when it records.

1. Select **DITHER** on the REC 4 page to open the **DITHER** screen.(see “Menu operation procedures” on page 22)



2. Set the dither mode.

Option	Meaning
OFF (default)	No dithering is conducted. Unusable quantization bits (17 and higher) are cut, while the 16th bit and below are recorded as is.
DITHER	Random noise (white noise) that is half the size of the smallest quantization bit (16th bit) is added, generating fluctuation in the border between the 16th and 17th bits and suppressing quantization noise.
NOISE SHAPE	This is linear noise shaping. Quantization noise itself is fed back and differentiated to suppress the noise and expand the dynamic range.

3. Confirm the setting and return to the Menu Screen.

Using the sampling rate converter

This unit has a built-in sampling rate converter, so it is possible to record with a sampling frequency that is different from the digital input sources.

When the sampling rate converter is on, the **SRC** icon appears in the recording function activation status area on the recording screen.

1. Select **SRC** on the REC 4 page to open the **SRC** screen.(see “Menu operation procedures” on page 22)



2. Turn the sampling rate converter (SRC) on or off.
Options: OFF (default), ON
3. Confirm the setting and return to the Menu Screen.

NOTE

- If you try to record a digital signal through a digital input connector with the sampling frequency that is different from the one set on the **SAMPLING RATE** screen when the sampling rate converter (SRC) is off, a “-- DIM ERROR -- Digital input is illegal.” message will appear.(see “Setting the recording file format” on page 57)
- The sampling rate converter operation range is 32–192 kHz.

Setting the pause mode

You can set the unit to either increment the track number (create a new file) or not when you switch it from recording to recording standby (pausing).

1. Select **PAUSE MODE** on the REC 4 page to open the **PAUSE MODE** screen.(see “Menu operation procedures” on page 22)



2. Set the pause mode.

Option	Meaning
SAME TRACK (default)	Track number not incremented when switching from recording to recording standby.
NEW TRACK	Track number incremented when switching from recording to recording standby.

3. Confirm the setting and return to the Menu Screen.

CAUTION

This cannot be changed when recording or in recording standby.

Skipping recording standby before recording (direct recording)

Recording can be started without entering recording standby first.

When this function is on, pressing the **RECORD** button will start recording immediately.

1. Select **DIRECT REC** on the REC 4 page to open the **DIRECT REC** screen.(see “Menu operation procedures” on page 22)



2. Turn the direct recording function on or off.
Options: OFF (default), ON
3. Confirm the setting and return to the Menu Screen.

Recording a few seconds in advance (pre-recording)

Using the pre-recording function, the built-in memory can capture up to 5 seconds of the signal input when the unit is in recording standby before recording is started normally.

1. Select **PRE REC** on the **REC 5** page to open the **PRE REC** screen.(see “Menu operation procedures” on page 22)



2. Set the length of pre-recording.
Options: OFF (default), 1sec, 2sec, 3sec, 4sec, 5sec
3. Confirm the setting and return to the Menu Screen.

NOTE

If the amount of time in recording standby is less than the set time, that amount of time is recorded instead.

Using the synchronized recording function

When the synchronized recording function is on, recording will start automatically when a signal is input that exceeds the sync LEVEL set in advance. After starting recording, recording will automatically pause if the signal stays below the sync level for the set STOP TIME.

Synchronized recording settings

Select **SYNC REC** on the **REC 5** page to open the **SYNC REC** screen. Use the **SYNC REC** screen to make synchronized recording settings.(see “Menu operation procedures” on page 22)



Turning the synchronized recording function on/off

Select the **MODE** item, and turn the synchronized recording function on/off.

Options: OFF (default), ON

NOTE

*When the synchronized recording function is on, the **SYNC REC** icon appears in the recording function activation status area on the recording screen.*

Setting the synchronized recording function sync level

Select **LEVEL**, and set the synchronized recording sync level.

Options: -72dB, -66dB, -60dB, -54dB, -48dB, -42dB (default), -36dB, -30dB, -24dB

Setting the delay before recording starts

Select **DELAY**, and set the delay until recording starts after a signal that exceeds the sync level is detected (in 10msec (0.01sec) increments).

By setting this to a negative value, recording can be started before signal detection (using the memory buffer).

Options: -1000msec - 0msec (default, 10msec increments) - +1000msec

Setting the condition to return to recording standby

Select **STOP TIME**, and set the amount of time until recording standby resumes after the signal goes below the sync level.

Options: 1MF, 5sec (default) - 30sec

Sync recording operation overview

When the sync recording function is on and the unit is in recording standby, recording will start and stop automatically in response to input source levels.

- When a signal higher than the sync level is input, recording will start automatically. However, if a signal lower than the sync level does not continue for at least one second after the unit is put into recording standby, recording will not start automatically even though input is detected.

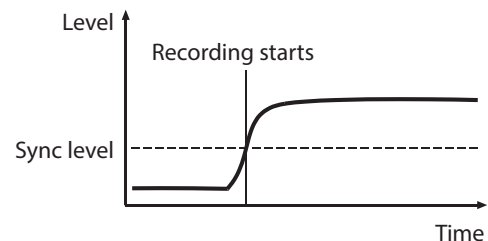

NOTE

In the above example, DELAY is set to 0msec (default). By changing the DELAY item, you can change the point when recording starts.

- During recording, when the signal stays below the sync level for the amount of time set with the **STOP TIME** item, recording will automatically pause.

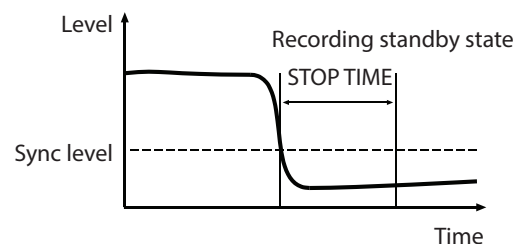

NOTE

If STOP TIME is set to 1MF, recording will not pause automatically even if the signal stays below the sync level.

- To disable sync recording, set the **SYNC REC** screen **MODE** item to OFF.(see “Synchronized recording settings” on page 61)

7 – Recording

If the sync level is too high

If the sync level is set too high, the beginnings of tracks that start quietly might not be recorded, for example.

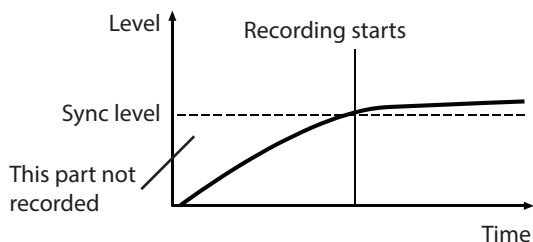

If the sync level is too low

When in recording playback, if the source has a high noise level that exceeds the sync level, sync recording will not start.

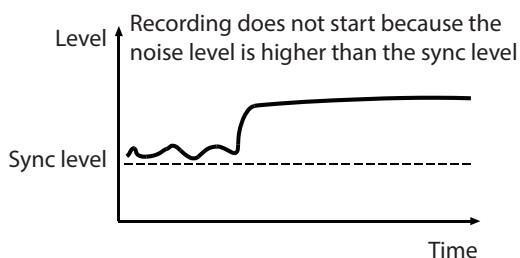

Incrementing track numbers during recording

Track numbers can be incremented manually or automatically when set conditions are met during recording. Each time the track number is incremented, a new audio file is created.

NOTE

- When new tracks are created, incremental numbers are added to the end of each file name.
- If the file name of a track to be created would be the same as that of an existing file, the number will be incremented until the new file has a unique name.

Incrementing track numbers manually

You can press the **RECORD [TRACK INC]** button (or remote control **RECORD** button) during recording to increment the track number. You cannot, however, create a track that is less than four seconds long.

NOTE

If tracks are recorded in WAV format, you can also divide and combine them after recording using the editing functions. (see "Dividing tracks (DIVIDE)" on page 67), (see "Combining tracks (COMBINE)" on page 68)

CAUTION

Depending on the SD card or USB flash drive, incrementing tracks repeatedly in a short amount of time when recording in MP3 format could cause a "RECORD Error Buffer overflow" error message to appear and recording to stop. To prevent this, leave some time between each incrementation.

Incrementing track numbers automatically

Use the menu to select the automatic track incrementation mode and make specific settings.

When the automatic track incrementation function is on, the **A.TRACK** icon appears in the recording function activation status area on the recording screen.

Automatic track incrementation function settings can be changed anytime, even after starting recording.

NOTE

If tracks are recorded in WAV format, you can also divide and combine them after recording using the editing functions. (see "Dividing tracks (DIVIDE)" on page 67), (see "Combining tracks (COMBINE)" on page 68)

1. Select the **AUTO TRACK** item on the **REC 5** page to open the **AUTO TRACK** screen. (see "Menu operation procedures" on page 22)



2. Set the automatic track incrementation mode.

Option	Meaning
OFF (default)	Tracks will not be automatically incremented.
LEVEL	The track number will be incremented when the signal stays below the automatic track level (AUTO TRACK screen LEVEL setting) for at least two seconds, and then the signal exceeds the level.
DD	When a digital source (CD, DAT, MD) is being recorded through a digital input, track numbers will be incremented when track divisions on the source are detected. When recording an analog source or a digital source in any other manner, however, LEVEL mode will be used and tracks will be implemented in response to the input level.
SIZE	The track number will be incremented when the file reaches a set size.

3. The setting items differ depending on the set automatic track incrementation mode.

LEVEL mode selected



Select the LEVEL item, and set the automatic track incrementation level.

Options: -72dB, -66dB, -60dB, -54dB (default), -48dB, -42dB, -36dB, -30dB, -24dB

Select DELAY, and set the delay until incrementation after a signal is detected that exceeds the automatic track incrementation level (10 msec = 0.01 sec).

By setting this to a negative value, recording can be started before signal detection (using the memory buffer).

Options: -1000msec - 0msec (default, 10msec increments) - +1000msec

DD mode selected



Options: -1000msec - 0msec (default, 10msec increments) - +1000msec

SIZE mode selected



Options: 640MByte, 1GByte, 2GByte (default)

Adding marks manually when recording

You can manually add a mark to a file where you want it when recording, allowing you to find that point again quickly during playback.

NOTE

Moving between marks is only possible when stopped, playing back or in playback standby. (see "Moving to marks" on page 75)

Adding marks when recording

When recording or in recording standby and the Home Screen is open, press the **MULTI JOG** dial to add a mark at that point.

The number of the added mark will be shown on a pull-up at the bottom of the display.



NOTE

- Marks added to files by this unit during recording are stored in the files themselves. These marks can be used when playing back the file using software or equipment that supports the BWF format.
- The maximum number of marks that can be added to a file is 99. The mark data is stored in the file.
- You can also add marks when the unit is stopped, playing back or in playback standby. (see "Adding marks" on page 75)
- A mark added manually will be named MARK $\times\times$.*

* The $\times\times$ is a number given to all marks that is incremented in order.

7 – Recording

Adding marks automatically when recording

By turning the auto mark function on, you can have the unit add marks automatically when audio level overloads occur or when synchronization errors occur because external clock is lost. Using this function, you can quickly search for points where problems occurred during recording.

When the automatic mark function is on, the **A.MARK** icon appears in the recording function activation status area on the recording screen.

1. Select the **AUTO MARK** item on the **REC 5** page to open the **AUTO MARK** screen. (see “Menu operation procedures” on page 22)

AUTO MARK	<< >>: MOVE Cursor
OVER	OFF
TIME	OFF
UNLOCK	ON
REC	OFF
BOF	ON

2. Set the following automatic mark function settings.

OVER

Add a mark whenever the audio level reaches 0 dB (full bit).

Options: OFF (default), ON

TIME

Set a time interval for adding marks automatically.

Options: OFF (default), 1min, 10min, 15min, 30min, 1hour

UNLOCK

Add a mark whenever synchronization with the external clock is lost.

Options: OFF, ON (default)

REC

Add a mark whenever recording starts if the pre-recording function is on.

Options: OFF (default), ON

BOF

Add a mark when a buffer overflow occurs.

Options: OFF, ON (default)

NOTE

When the **AUTO MARK** screen is open, use the **◀◀ [A-B]** and **▶▶ [INPUT]** buttons to move the cursor between setting items.

3. When the cursor is at the **BOF** item, press the **MULTI JOG** dial to confirm the setting and return to the menu.

NOTE

- After an **OVER** or **UNLOCK** mark is added, the same type of mark will not be added again until at least 10 seconds have passed.
- When an **OVER** occurs, a mark named **OVER_{xxx}*** will be added.
- For **TIME**, a mark named **TIME_{xxx}*** will be added.
- For **UNLOCK**, a mark named **UNLK_{xxx}*** will be added.
- For **REC**, a mark named **REC_{xxx}*** will be added.
- For **BOF**, a mark named **BOF_{xxx}*** will be added.

- * The **xxx** is a number given to all marks that is incremented in order.

Recording duration

The table below shows maximum recording times by file format on SD/SDHC/SDXC cards and USB flash drives of different capacities (in hours and minutes).

File format (capacity when recording)		SD/SDHC/SDXC card or USB flash drive capacity					
		4 GB	8 GB	32 GB	64 GB	128 GB	
WAV/BWF 16bit (STEREO/MONO (2ch))	44.1kHz	6 hours 17 minutes	12 hours 35 minutes	50 hours 23 minutes	100 hours 39 minutes	201 hours 16 minutes	
	48kHz	5 hours 47 minutes	11 hours 34 minutes	46 hours 17 minutes	92 hours 36 minutes	185 hours 13 minutes	
	96kHz	2 hours 53 minutes	5 hours 47 minutes	23 hours 08 minutes	46 hours 17 minutes	92 hours 36 minutes	
WAV/BWF 24bit (STEREO/MONO (2ch))	44.1kHz	4 hours 11 minutes	8 hours 23 minutes	33 hours 35 minutes	67 hours 05 minutes	134 hours 24 minutes	
	48kHz	3 hours 51 minutes	7 hours 42 minutes	30 hours 51 minutes	61 hours 44 minutes	123 hours 28 minutes	
	96kHz	1 hours 55 minutes	3 hours 51 minutes	15 hours 25 minutes	30 hours 51 minutes	61 hours 44 minutes	
MP3 (STEREO/MONO (2ch))	64kbps	44.1kHz/48kHz	About 138 hours	About 277 hours	About 1111 hours	About 2222 hours	About 4444 hours
	128kbps	44.1kHz/48kHz	69 hours 26 minutes	About 138 hours	About 555 hours	About 1111 hours	About 2222 hours
	192kbps	44.1kHz/48kHz	46 hours 17 minutes	92 hours 35 minutes	About 370 hours	About 740 hours	About 1480 hours
	256kbps	44.1kHz/48kHz	34 hours 43 minutes	69 hours 26 minutes	About 277 hours	About 555 hours	About 1111 hours
	320kbps	44.1kHz/48kHz	27 hours 46 minutes	55 hours 33 minutes	About 222 hours	About 444 hours	About 888 hours

- The recording times shown above are estimates. They might differ depending on the SD/SDHC/SDXC card or USB flash drive in use.
- The recording times shown above are not continuous recording times, but rather they are the total possible recording times for the SD/SDHC/SDXC card or USB flash drive.
- If recorded using the MONO (MIX) setting, maximum recording times will be about double those above.
- Recording using dual format (WAV16+MP3) settings, will have shorter recording times than WAV/BWF16bit (STEREO) recording.

8 – Using the Edit Menu

Edit menu operations

Press the **KEY [EDIT]** button while pressing the **SHIFT** button to open the edit menu pop-up.



Turn the **MULTI JOG** dial to select the desired operation, and press the **MULTI JOG** dial to execute it as follows.

NOTE

When a protected SD card is loaded in the unit, the following operations are not possible. (see "SD card write-protection switches" on page 27)

DELETE

Delete the selected track. (see "Deleting tracks (DELETE)" on page 66)

DIVIDE

Divide the selected track. (see "Dividing tracks (DIVIDE)" on page 67)

COMBINE

Combine the selected tracks. (see "Combining tracks (COMBINE)" on page 68)

UNDO

Undo an edit menu operation. (see "Undoing edit menu operations (UNDO)" on page 68)

Deleting tracks (DELETE)

Tracks shown on the Home Screen can be deleted from USB flash drives and SD cards.

This is only possible when the playback mode is set to **CONTINUE**.

1. Select the track to delete, and press the **KEY [EDIT]** button while pressing the **SHIFT** button to open the edit menu pop-up. (see "Edit menu operations" on page 66)
2. Select **DELETE**, and press the **MULTI JOG** dial. The following pop-up message will appear.



NOTE

*Press the **MENU [JOG]** button to cancel deletion.*

3. Press the **MULTI JOG** dial. A second confirmation pop-up message will appear.
4. Press and hold the **MULTI JOG** dial to delete the selected track from the USB flash drive or SD card. A "Deleting Track . . ." pop-up, for example, appears while the track is being deleted.

NOTE

Immediately after deleting a file, you can undo the deletion. (see "Undoing edit menu operations (UNDO)" on page 68)

Dividing tracks (DIVIDE)

A recorded track can be divided into two tracks at a specified position.

This is only possible when the playback mode is set to CONTINUE.

CAUTION

- MP3 tracks cannot be divided.
- The original track does not remain after division.

NOTE

The division operation can be undone immediately after division. (see "Undoing edit menu operations (UNDO)" on page 68)

1. Select the track to divide, and press the **KEY [EDIT]** button while pressing the **SHIFT** button to open the edit menu pop-up. (see "Edit menu operations" on page 66)
2. Turn the **MULTI JOG** dial to select the **DIVIDE** item.
3. Press the **MULTI JOG** dial to open the Home Screen. Division rehearsal mode becomes active, and the **TRACK** display mode on the Home Screen shows 10msec units for the track elapsed time. The **PLAY** and **PAUSE [CALL]** buttons on the main unit also blink.



10msec increments

4. Use the scrub playback function to set the division point accurately. Turn the **MULTI JOG** dial to scrub playback and move to the division point

5. After finding the division point, press the **MULTI JOG** dial. A confirmation pop-up message appears.



Press the **MENU [JOG]** button to change the division point. When division rehearsal mode becomes active again, repeat the procedure from step 3.

Proceed to the next step 6 to execute the division.

NOTE

- After dividing, two new tracks with "_a" and "_b" added to the end of the original track name are created.

Examples:

Track name before division

T001-20170101-123456.wav

Track names after division

T001-20170101-123456_a.wav

T001-20170101-123456_b.wav

- If the edited track was assigned to a playlist, that playlist will become unplayable.

Delete it from the playlist on the **PLAYLIST EDIT** screen.

6. Press the **MULTI JOG** dial to divide the track. A pop-up window appears while dividing.



8 – Using the Edit Menu

Combining tracks (COMBINE)

Two recorded tracks can be combined into one track. This is only possible when the playback mode is set to CONTINUE.

CAUTION

- MP3 tracks cannot be combined.
- Two tracks cannot be combined if their sampling frequencies, channel counts or file formats differ.
- A track cannot be combined with itself.
- The original tracks do not remain after being combined.

NOTE

The combine operation can be undone after combining. (see “Undoing edit menu operations (UNDO)” on page 68)

1. Select a track to combine, and press the **KEY [EDIT]** button while pressing the **SHIFT** button to open the edit menu pop-up. (see “Edit menu operations” on page 66)
2. Turn the **MULTI JOG** dial to select the **COMBINE** item.
3. Press the **MULTI JOG** dial to open the **TRACK COMBINE** screen where you can choose the other track to combine.



4. Turn the **MULTI JOG** dial to select the track to combine, and press the **MULTI JOG** dial to open a pop-up menu.
5. Select the **SELECT** item, and press the **MULTI JOG** dial. After a confirmation pop-up appears, the **PLAY** and **PAUSE [CALL]** buttons on the main unit blink and a four-second interval before and after the combination point plays back repeatedly.



Press the **MENU [JOG]** button to cancel combine. When the **TRACK COMBINE** screen reopens, repeat the procedure from step 4.

NOTE

- Combining creates a track with a name that links both original track names.

Example:

Track names before combining

T001-20170101-123456.wav

T002-20170101-234501.wav

Track name after combining

T001-20170101-123456_T002-20170101-234501.wav

- If the edited file was assigned to a playlist, that playlist will become unplayable. Delete it from the playlist on the **PLAY-LIST EDIT** screen.
6. Press the **MULTI JOG** dial to combine the tracks. A pop-up window appears while combining.

Undoing edit menu operations (UNDO)

Track division, combination and deletion operations in the edit menu can be undone immediately after they are executed. Moreover, immediately after a folder or file is deleted on the **BROWSE** screen, deletion can be undone. This is only possible when the playback mode is set to CONTINUE.

NOTE

When using the undo function, the track selected on the Home Screen before opening the edit menu does not matter.

1. Press the **KEY [EDIT]** button while pressing the **SHIFT** button to open the edit menu pop-up. (see “Edit menu operations” on page 66)
2. Turn the **MULTI JOG** dial to select the **UNDO** item.
3. Press the **MULTI JOG** dial. A confirmation pop-up message appears.



4. Press the **MULTI JOG** dial to undo. A pop-up window appears while undoing.

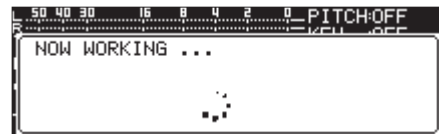

When undoing completes, the Home Screen opens.

NOTE

- Press the **MENU [JOG]** button to cancel undoing.
- If there are no file operations that can be undone (UNDO), **CAN'T UNDO** appears in a pop-up warning message.

9 – Timer Event Function

Turning the timer event function on/off

Timer events allow recording, playback, downloading and other operations to be conducted automatically at set times.

1. Select **TIMER EVENT** on the **TIMER EVENT** page to open the **TIMER EVENT** screen.(see “Menu operation procedures” on page 22)



2. Enable or disable the timer event function.

Option	Meaning
OFF (default)	This disables the timer event function.
ON	This enables the timer event function.

3. Confirm the setting and return to the Menu Screen.

NOTE

- The  icon appears on the Home Screen when the timer event function is on.
- The timer event function cannot be used when **PLAY AREA** is set to **PLAYLIST**.

Opening the timer event list screen

The timer event list screen shows the timer events that will be automatically executed at set times and allows you to work with them.

Select **TIMER EVENT LIST** on the **TIMER EVENT** page to open the timer event screen.(see “Menu operation procedures” on page 22)

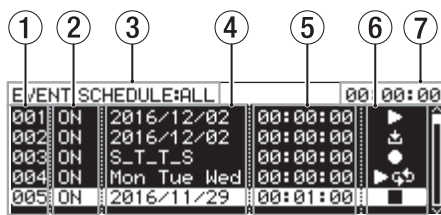

① Number

This shows the timer event number.

② ON/OFF status

This shows whether a timer event will be executed (ON) or not (OFF).

③ SCHEDULE status

Events in the designated range are shown.

Use the timer event list menu to set the display range.(see “Timer event bliss menu operations” on page 70)

Status	Meaning
ALL	All events shown
TODAY	Only today's events shown
YYYY/MM/DD	Events for the set date shown (year/month/day) Example: 2016/11/11

④ Event execution date/day

This shows the date or day the event will be executed.

• Date

Example: 2016/01/30

Events that repeat every month will be shown like 2017/**/30.

• Day

Events set for 3 days or less will be shown like Mon/Tue/Wed.

Events set for 4 days or more will be shown like _H__TF5 with just the first letters of the days.

• Every day







EVERY DAY will be shown.

⑤ Event execution time

This shows the time the event will be executed.

⑥ TYPE indicator

Icons are shown for different event types.

Icon	Meaning
	Playback
	Repeat playback
	Record
	Stop
	Download (from an FTP server)
	Delete before downloading (after all audio files in the current folder are deleted, download files from the FTP server)

⑦ Current time display (hour: minute: second)

This shows the current time of the built-in clock.

NOTE

If no events have been added, the screen will appear as shown below.

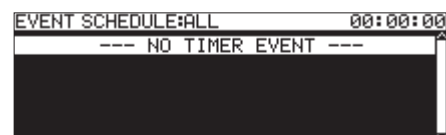

9 – Timer Event Function

Timer event bliss menu operations

Select the desired timer event on the timer event list screen, and press the **MULTI JOG** dial to open the timer event list pop-up menu.



Turn the **MULTI JOG** dial to select the desired operation, and press the **MULTI JOG** dial to execute it as follows.

SET TO ON/SET TO OFF

Set whether a timer event will be executed (ON) or not (OFF).

EDIT EVENT

Open the **EDIT EVENT** screen for the selected timer event.(see "Editing timer events" on page 70)

CREATE NEW EVENT

Create a new timer event.(see "Creating new timer events" on page 74)

DELETE

Delete the selected timer event.(see "Deleting timer events" on page 74)

DELETE ALL

Delete all added timer events.(see "Deleting all timer events" on page 74)

SHOW ALL

Show all added timer events.

SHOW TODAY

Show only timer events for today.

SHOW SPECIFIED DATE

Show only timer events for a specified date.

CANCEL

Close the event list menu.

Editing timer events

Select **EDIT EVENT**, and open the **EDIT EVENT** screen.

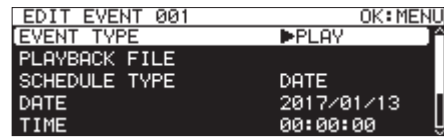

When **EVENT TYPE** is **PLAY** or **REPEAT PLAY**

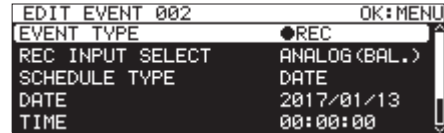

When **EVENT TYPE** is **REC**

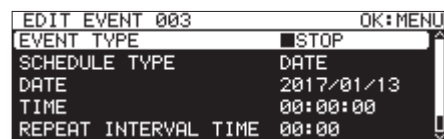

When **EVENT TYPE** is **STOP**

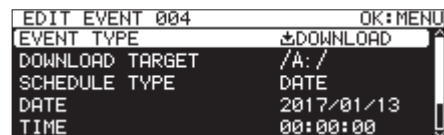

When **EVENT TYPE** is **DOWNLOAD** or **DEL&DOWNLOAD**

Press the **MENU [JOG]** button to confirm the contents and return to the event list screen.

Turn the **MULTI JOG** dial to select the desired item, and press the **MULTI JOG** dial to work with it as follows.

EVENT TYPE

Set/view the timer event that will be executed automatically at the set time.(see "Setting the event type" on page 71)

PLAYBACK FILE

If the **EVENT TYPE** setting is **PLAY** or **REPEAT PLAY**, the **PLAYBACK FILE** item will appear on the **EDIT EVENT** screen. Use this item to set/view the file that will be played back automatically at the set time.(see "Setting the playback area" on page 71)

REC INPUT SELECT

If the **EVENT TYPE** setting is **REC**, the **REC INPUT SELECT** item will appear on the **EDIT EVENT** screen. Use this item to set/view the input that will be used to automatically record at the set time.(see "Selecting the input to use when recording" on page 72)

DOWNLOAD TARGET

If the **EVENT TYPE** setting is **DOWNLOAD** or **DEL&DOWNLOAD**, the **DOWNLOAD TARGET** item will appear on the **EDIT EVENT** screen. Use this item to set/view the folder/file that will be used when downloading automatically from an FTP server at the set time. (see "Setting folders/files to use for FTP server download" on page 72)

SCHEDULE TYPE

Set/show the type of schedule used to execute the timer event. (see "Setting execution schedules for timer events" on page 72)

DATE

Set/view the year, month and day of timer event execution.(see “Setting dates for timer event execution” on page 73)

TIME

Set/view the time (hour: minute: second) of timer event execution.(see “Setting times for timer event execution” on page 73)

TIME MODE

Set/view whether playback of the playback file starts or stops at the set time.(see “Setting what happens at the time set for the playback timer event” on page 73)

REPEAT INTERVAL TIME

Set/view the frequency interval (hours: minutes) of an event that is executed repeatedly.(see “Setting the frequency intervals of events that repeat” on page 73)

REPEAT EVENT COUNT

Set/view how many times a repeated event is executed.(see “Setting the number of event repetitions” on page 74)

Setting the event type

1. Select **EVENT TYPE**, and open the **EVENT TYPE** screen.



2. Select the timer event that will be executed automatically at the set time.

Option	Meaning
PLAY	Playback
REPEAT PLAY	Repeat playback
REC	Recording
<input type="checkbox"/> STOP	Stop
DOWNLOAD	Download (from an FTP server)
DEL&DOWNLOAD	Delete before downloading (after deleting all audio files in the current folder, download files from the FTP server)

3. Press the **MULTI JOG** dial.
This confirms the setting and returns to the **EDIT EVENT** screen.

Setting the playback area

If the **EVENT TYPE** setting is **PLAY** or **REPEAT PLAY**, the **PLAYBACK FILE** item will appear on the **EDIT EVENT** screen.

1. Select the **PLAYBACK FILE** item, and press the **MULTI JOG** dial to open the **BROWSE** screen.

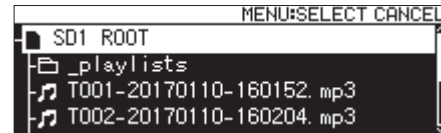

2. Select the desired file as the playback file, and return to the **EDIT EVENT** screen.

Selecting files/folders for playback by inputting path names

You can set a file name that has not yet been downloaded and is not on media in the unit.

On the **BROWSE** screen for FTP server folder selection, press the **MULTI JOG** dial to open a pop-up menu.



Select **KEYBOARD SCREEN** from the menu, and press the **MULTI JOG** dial to open the path name input screen.

On the path name input screen, input the path name for the item to be played back. Then, return to the **EDIT EVENT** screen. For details about how to edit the text, see [Editing textpage 59](#).

NOTE

- On a path name input screen, characters other than English letters, numerals and symbols cannot be input.
- If the path name is wider than the screen, use the **◀ [A-B]** and **▶▶ [INPUT]** buttons to move the cursor and scroll the path name left and right. If the left or right end is not being shown, “...” will appear at that end.
- To return to the **BROWSE** screen, select **BROWSE ▶** at the top right of the path input screen, and press the **MULTI JOG** dial.

9 – Timer Event Function

Selecting the input to use when recording

If the EVENT TYPE setting is REC, the REC INPUT SELECT item will appear on the EDIT EVENT screen.

1. Select REC INPUT SELECT, and open the REC INPUT SELECT screen.

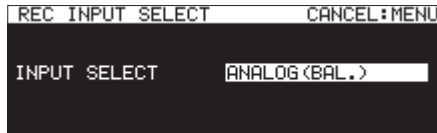

2. Select the input that will be used when recording automatically at the set time.

Options	Meaning
ANALOG (UNBAL.)	Input from ANALOG IN (UNBALANCED) L/R jacks
ANALOG (BAL.)	Input from MIC/LINE IN (BALANCED) L/R jacks
DIGITAL (COAX.)	Input from SPDIF IN jack
DIGITAL (HLR)	Input from AES/EBU IN jack
DIGITAL (Dante)	Input from IF-DA2 Dante interface card

NOTE

DIGITAL (Dante) can only be selected if an IF-DA2 Dante interface card (sold separately) is installed in the unit.

CAUTION

After setting this to DIGITAL (Dante), if the IF-DA2 Dante interface card is removed from the unit, recording events will still be executed without changing the input. This could result in audio not being recorded as desired.

3. Press the MULTI JOG dial.
This confirms the setting and returns to the EDIT EVENT screen.

Setting folders/files to use for FTP server download

If the EVENT TYPE setting is DOWNLOAD or DEL&DOWNLOAD, the DOWNLOAD TARGET item will appear on the EDIT EVENT screen.

1. Select DOWNLOAD TARGET, and press the MULTI JOG dial to open the FTP server DOWNLOAD TARGET screen.

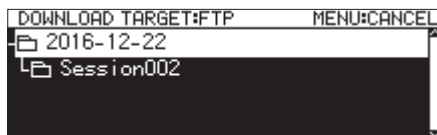

2. Select the folder/file you want to use for downloads on the FTP server BROWSE Screen and press the MULTI JOG dial to open a pop-up menu.
3. Select the SELECT item and press the MULTI JOG dial to set the folder/file for downloads, and return to the EDIT EVENT screen.

Selecting files/folders for download by inputting path names

Even when an FTP server cannot be connected, you can set names of items to be downloaded.

On the BROWSE screen for FTP server folder selection, press the MULTI JOG dial to open a pop-up menu.

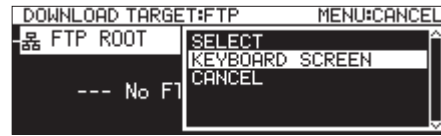

- Select KEYBOARD SCREEN from the menu, and press the MULTI JOG dial to open the path name input screen.



- On the path name input screen, input the path name for the item to be downloaded. Then, return to the EDIT EVENT screen. For details about how to edit the text, see Editing text page 59.

NOTE

- On a path name input screen, characters other than English letters, numerals and symbols cannot be input.
- “/” and “:” only appear when inputting FTP server paths.
- If the path name is wider than the screen, use the ◀◀ [A-B] and ▶▶ [INPUT] buttons to move the cursor and scroll the path name left and right. If the left or right end is not being shown, “...” will appear at that end.
- To return to the BROWSE screen, select BROWSE ▶ at the top right of the path input screen, and press the MULTI JOG dial.

Setting execution schedules for timer events

1. Select SCHEDULE TYPE, and open the SCHEDULE TYPE screen.

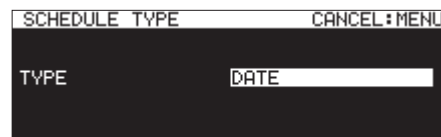

2. Select the type of schedule used to execute the timer event.

Option	Meaning
DAY OF WEEK	Timer events can be executed on set days of the week (every week).(see “Setting days for timer event execution” on page 73)
DATE	Timer events can be executed on set dates. (see “Setting dates for timer event execution” on page 73) , (see “Setting times for timer event execution” on page 73)
EVERY DAY	Timer events can be set to execute daily.

3. Press the MULTI JOG dial.
This confirms the setting and returns to the EDIT EVENT screen.

Setting days for timer event execution

When SCHEDULE TYPE is set to DAY OF WEEK, the DAY OF WEEK item appears on the EDIT EVENT screen, and you can set which days the event executes.

1. Select DAY OF WEEK, and open the DAY OF WEEK screen.

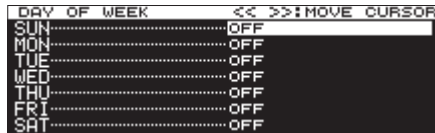

2. Turn the **MULTI JOG** dial to turn an item on/off. Press the **MULTI JOG** dial to move the cursor to the next line. Use the **◀ [A-B]** and **▶ [INPUT]** buttons to move the cursor.
Options: OFF (default), ON
3. Press the **MULTI JOG** dial when on the bottom row to confirm the settings and return to the EDIT EVENT screen. Press the **MENU [JOG]** button to cancel setting changes and return to the EDIT EVENT screen.

Setting dates for timer event execution

When SCHEDULE TYPE is set to DATE, you can set the year/month/day that the timer event executes on the DATE screen.

1. Select SCHEDULE TYPE DATE, and open the DATE screen.



2. Set the year, month and day of timer event execution.
3. The cursor will disappear and setting the date and time will complete after you change the year, month and day in order.

NOTE

The month can be set to monthly (**) if you want the event to occur every month of the year (01-12).

Setting times for timer event execution

1. Select SCHEDULE TYPE DATE, and open the TIME screen.



2. Set the time (hour: minute: second) of timer event execution.
Options: 00:00:00 (default) – 23:59:59
3. Turn the **MULTI JOG** dial to change the time setting. Press the **MULTI JOG** dial to move the cursor right. You can also use the **◀ [A-B]** and **▶ [INPUT]** buttons to move the cursor. Press the **MULTI JOG** dial when the cursor is on the second to confirm the setting and return to the EDIT EVENT screen.

Setting what happens at the time set for the playback timer event

1. Select TIME MODE, and open the TIME MODE screen.



2. Set whether playback of the playback file starts or stops at the set time.

Option	Meaning
START TIME	Set the event to start playback of the playback file at the set time.
END TIME	Set the event to end playback of the playback file at the set time.

Setting the frequency intervals of events that repeat

1. Select REPEAT INTERVAL TIME, and open the REPEAT INTERVAL TIME screen.



2. Set the frequency interval (hours: minutes) of the event that is executed repeatedly.
Options: 00:00 (default) – 23:59
3. After setting the hour and minute in order, the time will be set and the cursor will disappear.

9 – Timer Event Function

Setting the number of event repetitions

1. Select REPEAT EVENT COUNT, and open the REPEAT EVENT COUNT screen.

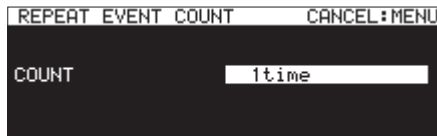

2. Set the number of times that event execution is repeated.
Options: 1time (default), 100times

NOTE

If the REPEAT EVENT COUNT screen is set to 1time, the event will not repeat.

Creating new timer events

1. Select CREATE NEW EVENT, and open the EDIT NEW EVENT screen.

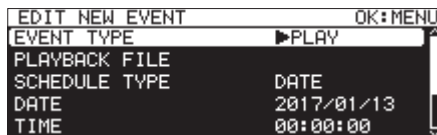

2. Make settings for the timer event.(see “Editing timer events” on page 70)

NOTE

A maximum of 200 events can be added and executed.
For example, if there are 25 events that are set to repeat 10 times each, the total number of events to execute would be 250 (10×25). Since this is too many, only the first 20 events in the list would be executed, bringing the total down to 200 (10×20). The last 5 events in the list would not be executed.

Deleting timer events

1. Select the timer event that you want to delete, and open the timer events list pop-up menu.(see “Timer event bliss menu operations” on page 70)
2. Select DELETE, and press the MULTI JOG dial.
A confirmation pop-up message appears.



3. Press and hold the MULTI JOG dial to delete the selected timer event.
When deleting completes, the EDIT EVENT screen reopens.

NOTE

Press the MENU [JOG] button to cancel timer event deletion.

Deleting all timer events

1. Open the timer event list pop-up menu.(see “Timer event bliss menu operations” on page 70)
2. Select DELETE ALL, and press the MULTI JOG dial.
A confirmation pop-up message appears.



3. Press and hold the MULTI JOG dial to delete all timer events.
When deleting completes, the EDIT EVENT screen reopens and ---NO TIMER EVENT--- appears.

NOTE

Press the MENU [JOG] button to cancel timer event deletion.

10 – Mark and Locate Functions

Mark function

Adding marks

Marks can be added in the following ways.

Including marks added by the automatic mark function, one file can have up to 99 marks added to it.

Adding marks manually

Press the **MULTI JOG** dial to add a mark at the current playback/recording point.

The mark will be named MARKxxx.



CAUTION

Marks can be added to MP3 files recorded by this unit, but marks cannot be used with other MP3 files.

Adding marks automatically

The automatic mark function allows the unit to add marks automatically during recording. For details about the automatic mark function, see Adding marks automatically when recording page 64.

The marks will be named according to type.

Reason mark added automatically	Mark name
Audio level reached 0 dB (full bit).	OVERxxx
At set time interval	TIMExxx
Synchronization with external clock lost	UNLKxxx
Point where recording started using pre-recording	RECxxx
Time when buffer overflow occurred	BOFxxx

Using marks

Select the **MARK LIST** item on the **MARK LIST** page to open the **MARK LIST** screen.(see “Menu operation procedures” on page 22)

No Mark Point is shown if the current file has no marks.

MARK LIST	T006-20170110-162605.m
MARK01	00:00:00.00
MARK02	00:00:03.38
MARK03	00:00:07.39
MARK04	00:00:10.80
MARK05	00:00:11.93

Select the desired mark on the **MARK LIST** screen and press the **MULTI JOG** dial to open the mark pop-up menu.

MARK LIST	T006-20170110-162605.m
MARK01	LOCATE
MARK02	EDIT TIME
MARK03	EDIT NAME
MARK04	DELETE
MARK05	DELETE ALL

Turn the **MULTI JOG** dial to select the desired item, and press the **MULTI JOG** dial to work with it as follows.

LOCATE

Move to the selected mark.(see “Moving to marks” on page 75)

EDIT TIME

Open the **EDIT MARK TIME** screen where you can edit the selected mark.(see “Editing mark locations” on page 76)

EDIT NAME

Open the **MARK NAME** screen where you can edit the name of the selected mark.(see “Editing mark names” on page 76)

DELETE

Delete the selected mark.(see “Deleting marks” on page 76)

DELETE ALL

Delete all marks in the current file.(see “Deleting all marks in the current file” on page 76)

SORT BY TIME

Show marks sorted by time.

SORT BY NAME

Show marks sorted by name.

INFO

Open a pop-up with the number of marks of each type in the current file.(see “Viewing mark information” on page 76)

CANCEL

Close the mark menu.

Moving to marks

Using the **MULTI JOG** dial to move to marks

When the home screen is open during playback or playback standby and marks have been added, turn the **MULTI JOG** dial to move to marks.

Using the menu to move to marks

1. Turn the **MULTI JOG** dial to select the mark to which you want to move.
2. Press the **MULTI JOG** dial to open the mark pop-up menu, select the **LOCATE** item and press the **MULTI JOG** dial to move to the selected mark.(see “Using marks” on page 75)

10 – Mark and Locate Functions

Editing mark names

1. Select the mark with the name that you want to edit and press the **MULTI JOG** dial to open the mark pop-up menu. (see “Using marks” on page 75)
2. Select **EDIT NAME** in the mark menu, and press the **MULTI JOG** dial to open the **MARK NAME** screen.

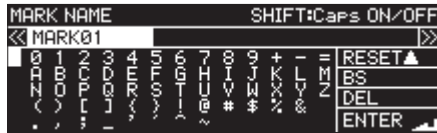

3. Input the mark name.
For details about how to edit the mark name, see Editing textpage 59.

NOTE

- The names of marks created by the automatic mark function cannot be changed.
- Editing the names of marks is only possible when stopped or in playback standby.

Deleting marks

1. Select the mark that you want to delete and press the **MULTI JOG** dial to open the mark pop-up menu.(see “Using marks” on page 75)
2. Select **DELETE** in the mark menu, and press the **MULTI JOG** dial.
3. A confirmation pop-up message will appear.
Press the **MULTI JOG** dial again to open a second confirmation pop-up message.
4. Press and hold the **MULTI JOG** dial to delete the selected mark.

NOTE

Deleting marks is only possible when stopped or in playback standby.

Deleting all marks in the current file

1. Press the **MULTI JOG** dial to open the mark pop-up menu. (see “Using marks” on page 75)
2. Select **DELETE ALL** in the mark menu, and press the **MULTI JOG** dial.
3. A confirmation pop-up message will appear.
Press the **MULTI JOG** dial again to open a second confirmation pop-up message.
4. Press and hold the **MULTI JOG** dial to delete all marks in the current file.

NOTE

Deleting marks is only possible when stopped or in playback standby.

Editing mark locations

You can use the **MULTI JOG** dial to edit the positions (times) of added marks (marks named “MARK:xx”).

NOTE

- The names of marks created by the automatic mark function cannot be changed.
 - Editing the locations of marks is only possible when stopped or in playback standby.
1. Select the mark with the location that you want to edit and press the **MULTI JOG** dial to open the mark pop-up menu. (see “Using marks” on page 75)
 2. Select **EDIT TIME** in the mark menu, and press the **MULTI JOG** dial.
 3. When the **EDIT MARK TIME** screen opens, use the **MULTI JOG** dial to change the time.



Press the **MULTI JOG** dial when the cursor is in the last field to confirm the setting and return to the **MARK LIST** screen.

NOTE

- When editing, you can press the **MENU [JOG]** button to cancel the changes and return to the **MARK LIST** screen.
- You can also use a USB keyboard to input numbers.

Viewing mark information

Press the **MULTI JOG** dial to open the mark pop-up menu, select the **INFO** item and press the **MULTI JOG** dial again to show the numbers of marks of different types in the current file.(see “Using marks” on page 75)

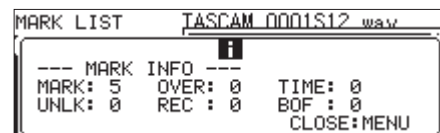

Press the **MENU [JOG]** button to close the pop-up.

Locating to a specific time

You can locate to a specific time using a USB keyboard when stopped, playing back or in playback standby.

CAUTION

Locating is not possible if the playback mode is PROGRAM or RANDOM or the playback area is PLAYLIST or FOLDER.

When the Home Screen is open, press the * (asterisk) key to clear the track number and time display and enable numerical input. Use the keypad to enter numbers in the following order.

- Track number: 3 digits
- Time elapsed from track beginning in hours, minutes, seconds and 10msec increments (2 digits each)

For example, enter the following numbers in order to specify the location 1 minute and 30 seconds from the beginning of track 2.

0 → 0 → 2 → 0 → 0 → 0 → 1 → 3 → 0 → 0 → 0

After inputting the 11th digit, the unit will automatically locate to the specified time.

The status of the unit after locating will be the same as it was before (stopped, in playback standby or playing).

For this reason, playback will resume at the new time after locating during playback.

NOTE

Using the Backspace or / (backslash) key on the USB keyboard will delete the last input number.

Locating before completely specifying the time

Before inputting all the numbers to specify a time, you can locate to the time specified immediately by pressing the Enter key on the USB keyboard, the **MULTI JOG** dial or the **PLAY** or **PAUSE [CALL]** button on the unit.

For example, entering the following incomplete time.

0 → 0 → 2 → 0 → 0 → 1 → 2

Press the **PLAY** button to locate to 12 minutes from the beginning of track 2.

What happens after locating depends on which control was pressed.

If the **MULTI JOG** dial was pressed:

Playback or playback standby is resumed according to the state before locating.

If the **PLAY** button was pressed:

Playback starts.

If the **PAUSE [CALL]** button was pressed:

The unit enters playback standby.

11 – Network Functions

Network function settings

The unit can be connected to a network using its Ethernet connector, allowing file transfer and external control of the unit. Use the NETWORK 1 and NETWORK 2 pages to make network function settings.

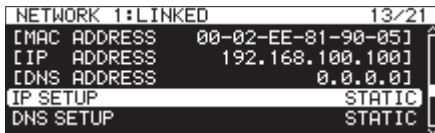

LINKED/UNLINKED

The status of the network link between devices is shown after the NETWORK page.

Status	Meaning
LINKED	A link is established.
UNLINKED	A link is not established.

MAC ADDRESS

This shows the unit's MAC address.

IP ADDRESS

This shows the current IP address.

DNS ADDRESS

This shows the IP address of the DNS server.

IP SETUP

This shows the setting status of the MODE item on the IP SETUP screen.

Select the IP SETUP item, and press the MULTI JOG dial to open the IP SETUP screen.

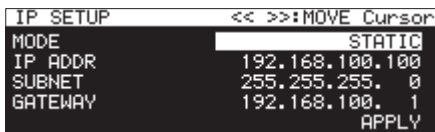

When MODE set to STATIC



When MODE set to AUTO

MODE item:

Set the IP address setting mode.

Option	Meaning
STATIC	Set the IP ADDR, SUBNET and GATEWAY items on the IP SETUP screen manually.
AUTO (default)	Set the IP ADDR, SUBNET and GATEWAY items on the IP SETUP screen automatically. Use this setting if there is a DHCP server on the network.

IP ADDR/SUBNET/GATEWAY items:

When the IP SETUP screen MODE item is set to STATIC, the IP ADDR, SUBNET and GATEWAY items appear and their settings can be changed.

Options: 0 – 255

(IP ADDR item default: 192. 168. 100. 100)

(SUBNET item default: 255. 255. 255. 0)

(GATEWAY item default: 192. 168. 100. 1)

When MODE is set to **STATIC**, press the **MULTI JOG** dial on **APPLY** in the last line to confirm the changed settings and return to the Menu Screen.

NOTE

Press the **MENU [JOG]** button to cancel the menu operation and return to the Menu Screen.

DNS SETUP

This shows the setting status of the MODE item on the DNS SETUP screen.

Select DNS SETUP, and press the **MULTI JOG** dial to open the DNS SETUP screen.



When MODE set to STATIC



When MODE set to AUTO

On the DNS SETUP screen, set the IP address of the DNS server so the IP address can be looked up from the server name.

MODE item:

Set the IP address setting mode.

Option	Meaning
STATIC	Set the IP address of the DNS server manually.
AUTO (default)	Set the IP address of the DNS server automatically. Use this setting if there is a DHCP server on the network that will return the IP address of the DNS server.

DNS ADDR item:

When the DNS SETUP screen MODE item is set to STATIC, a DNS ADDR item appears and its setting can be changed.

Options: 0 – 255 (default: 0. 0. 0. 0)

When MODE is set to STATIC, press the **MULTI JOG** dial on APPLY in the last line to confirm the changed settings and return to the Menu Screen.

NOTE

Press the **MENU [JOG]** button to cancel the menu operation and return to the Menu Screen.

IP PASSWORD

Select the PASSWORD item, and press the **MULTI JOG** dial to open the PASSWORD screen.



Set the password (default: SS-R250N).

Use up to 10 characters.

For details about how to edit the text, see Editing textpage 59.

NOTE

Press the **MULTI JOG** dial on PRESET to input the default: "SS-R250N".

FTP client function settings

FTP client function settings can be made on the FTP CLIENT page.

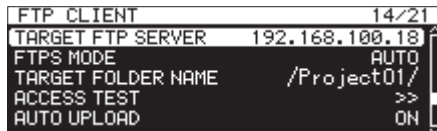

TARGET FTP SERVER

This opens the TARGET FTP SERVER screen.

Make various settings for FTP server connections.

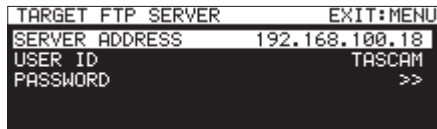

SERVER ADDRESS item:

Set the address of the FTP server being connected.

USER ID item:

Set the user ID to use when connecting to the FTP server.

PASSWORD item:

Set the password to use when connecting to the FTP server.

FTPS MODE

This shows the setting status of the MODE item on the FTPS MODE screen.

Select FTPS MODE, and press the **MULTI JOG** dial to open the FTPS MODE screen.



Set the mode used for SSL encryption of data sent and received by FTP on the FTPS MODE screen.

MODE item:

Option	Meaning
AUTO (default)	Using this mode, the unit will try to connect using FTPS that is encrypted by SSL. If connection is not possible, it will try to connect using ordinary FTP.
OFF	In this mode, the unit connects by ordinary FTP.

NOTE

- If the FTP server being connected does not support FTPS, the transmission of data using this unit's FTP client might be slower if set to AUTO.
- If connection encrypted by SSL is not necessary, setting the FTPS MODE to OFF might increase the data transmission speed.
- This unit's FTPS supports Explicit mode.
- Encryption protocol standards
 - SSLv3/TLSv1 supported
 - TLSv1 support includes TLSv1.0/1.1/1.2
 - Encryption algorithms: ARC4 (RC4), DES, 3DES, AES
 - Hash algorithms: MD5, SHA1, SHA256

TARGET FOLDER NAME

This sets the default folder on the FTP server used when uploading to it and downloading from it.

1. Select TARGET FOLDER NAME, and press the **MULTI JOG** dial to open the FTP server BROWSE screen.
2. Select the folder to use on the FTP server BROWSE screen and press the **MULTI JOG** dial to open a pop-up menu. Select the SELECT item, and return to the menu screen.

Overview of file operations using an FTP client application

1. Reading files from the unit
Except for the file that is currently being recorded, reading files from the unit is always possible.
2. Adding new files to the unit
Adding new files to the unit is always possible.
If BWF, WAV or MP3 files are added to the current folder during recording, files will be shown in the list in order from existing files to recorded files and then added files.
3. Overwriting existing files on the unit
The current file can only be overwritten when the unit is stopped.
Overwriting all other existing files on the unit is always possible. However, if the **PLAY MODE** item on the **PLAY MODE** screen is set to **ALL** and the unit is playing, overwriting the file after the current file might not be possible depending on the timing. (see “Setting the play mode” on page 31)

CAUTION

- *Problems might occur if the size, number of channels, bit depth or sampling frequency of the overwritten file differs from the original file.
An error message might appear if playback is attempted when a problem has occurred.
Delete that file from the USB flash drive or SD card to resolve the problem and stop the error message from appearing.*
 - *Do not overwrite existing audio files with files that use different sampling frequencies. Doing so could make it impossible to resolve the problem*
4. Deleting files on the unit
The current file can only be deleted when the unit is stopped.
Files other than the current file can be deleted at any time. Since discrepancies between system and audio files will occur after deleting a file, system files will be automatically updated (after stopping if playing back or recording). A **WRITING SYSTEM FILE** pop-up message will appear at such times.

CAUTION

*Playback and recording are disabled while the **WRITING SYSTEM FILE** message appears.
Be aware of the timing when deleting folders and files from an FTP client.*

5. Adding new folders to the unit
Adding new folders to the unit is always possible.
6. Deleting folders on the unit
The current folder can only be deleted when the unit is stopped.
Folders other than the current folder can be deleted at any time.
7. Change the names of files and folders on the unit
The names of files and folders on the unit cannot be changed.

Remote control

Remote control of this unit by Ethernet using Telnet through port 23 is possible.

Required settings for Telnet connection

The following settings are necessary to connect to this unit by Telnet.

IP address: The IP address of the unit is shown in the **IP ADDRESS** item on the **NETWORK 1** page.

Port number: 23

Password: **SS-R250N** (default) (Case-sensitive) This can be changed on the **PASSWORD** screen. (see “Network function settings” on page 78)

Connecting to this unit by Telnet

1. After connecting to this unit by Telnet with the above IP address and port number, press the computer Enter key.
2. “**Enter Password**” will appear on the Telnet console. Input the above password and press the Enter key.
3. When login succeeds, “**Login Successful**” will appear on the Telnet console.
Input “**exit**” and press the Enter key to end the Telnet connection.

NOTE

- *Three Telnet connections are possible at the same time.*
- *Telnet connection is not possible when **232C/PARA/NETWORK** is set to **LOCK** on the **LOCK SETUP** screen. If the setting is changed to **LOCK** when there is a Telnet connection, the connection will be interrupted. (see “Setting the lock function” on page 29)*
- *If a **NETWORK 1** or **NETWORK 2** page setting is changed when there is an Telnet connection, the connection will be interrupted.*
- *For information about this unit's Telnet command protocol, please contact the TASCAM customer support service.*

11 – Network Functions

Setting the SNTP function

Use the **SNTP** page to make settings for automatically synchronizing with the date and time of an Internet time server.



SNTP STATUS

This shows the current status of the SNTP function.

Message	Status
SUCCESSFUL UPDATE	The time was updated properly.
SUCCESS UPDATE (SKEW)	A delay occurred, but the time was updated.
STARTING UP	The unit is preparing for operation.
ACCESSING SERVER	The unit is connecting with a server.
DISABLED	The SNTP function is disabled.
WAITING FOR NETWORK	The unit is waiting to confirm the network connection.
SERVER NAME NOT FOUND	The server name could not be found on the DNS server.
SERVER NAME FOUND	The server name was found on the DNS server.
SERVER CONNECT FAILED	The server has not responded.
REFUSING CONNECTIONS	Server responded, but is refusing additional connections; select a different SNTP server.

SNTP UPDATE

This shows the setting status of the **MODE** item on the **SNTP UPDATE** screen.

Select **SNTP UPDATE**, and open the **SNTP UPDATE** screen. (see “Menu operation procedures” on page 22)



MODE item:

Set the SNTP function update mode.

Option	Meaning
DISABLE (default)	Do not use an SNTP function update mode.
START UP	When the unit starts up, get the time from an NTP server and use it to set the built-in clock.
START UP/24CYCLE	Get the time from an NTP server and use it to set the built-in clock when the unit starts up, as well as when the time set with the TIME item occurs every 24 hours.

TIME item:

Set the time to acquire the time from the NTP server.

Options: 00:00 – 00:09 – 23:00 – 23:09 (01:00 steps)
(default: 00:00 – 00:09)

NOTE

- When using the SNTP function, you must set the **NETWORK 1** page **DNS SETUP** item and the **NTP Server** item, which is explained below.
- On this screen, local time is set, not Coordinated Universal Time (UTC).
- Since access to SNTP servers on the hour could result in congestion, the unit will access the SNTP server randomly during the first 10 minutes of the hour.

NTP SERVER

This shows the setting status of the **NTP SERVER** screen.

Select **NTP SERVER**, and open the **NTP SERVER** screen. (see “Menu operation procedures” on page 22)

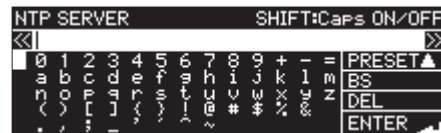

Edit the NTP server name, which must have no more than 32 characters (default: ntp.nict.jp).

For details about how to edit the text, see Editing text page 59.

NOTE

Press the **MULTI JOG dial** on **PRESET ▲** to open a pull up menu.



Turn the **MULTI JOG dial** to select a menu item, and press the **MULTI JOG dial** to input the preset value of that item.

Press the **MENU [JOG]** button to close the pull-up menu.

TIME ZONE

This shows the setting status of the TIME ZONE item on the TIME ZONE screen.

Select TIME ZONE, and press the **MULTI JOG** dial to open the TIME ZONE screen.(see “Menu operation procedures” on page 22)



TIME ZONE item:

Set the time offset from Coordinated Universal Time (UTC).

Options: -12:00 – +14:00
(00:15/step) (default: +09:00)

NOTE

- To use Japan Standard Time (JST), set this to +09:00.
- For the United States, use one of the following settings.

Zone	Setting
Pacific Standard Time (PST) zone	-08:00
Mountain Standard Time (MST) zone	-07:00
Central Standard Time (CST) zone	-06:00
Eastern Standard Time (EST) zone	-05:00

DAYLIGHT SAVING

This is the settings screen for the daylight saving time function, which advances the built-in clock during the set period.

This shows the setting status of the MODE item on the DAYLIGHT SAVING screen.

Select ENABLE for the MODE, and press the **MULTI JOG** dial to open the daylight saving time function settings screen.(see “Menu operation procedures” on page 22)

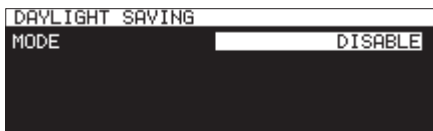

MODE set to DISABLE

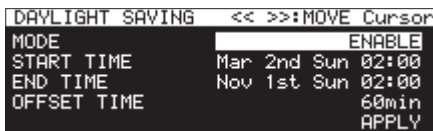

MODE set to ENABLE

MODE item:

Set whether or not to enable the daylight saving time function.

Options

DISABLE (default): Do not use the daylight saving time function.

ENABLE: Use the daylight saving time function.

START TIME/END TIME items:

Set when to start and end use of the daylight saving time function.

Setting item	Options
Month	Jan, Feb, Mar, Apr, May, Jun, Jul, Aug, Sep, Oct, Nov, Dec
Week	1st, 2nd, 3rd, 4th, 5th, Last
Day	Sun, Mon, Tue, Wed, Thu, Fri, Sat
Time	00:00 – 24:00 (01:00/step)

START TIME defaults: Mar/2nd/Sun/02:00

END TIME defaults: Nov/1st/Sun/02:00

OFFSET TIME item:

Set the amount to advance the clock during daylight saving time.

Options: 30min, 60min (default)

NOTE

On this screen, local time is set, not Coordinated Universal Time (UTC).

When the MODE item is set to ENABLE, press the **MULTI JOG** dial on APPLY in the last line to confirm the changed settings and return to the Menu Screen.

NOTE

Press the **MENU [JOG]** button to cancel the menu operation and return to the Menu Screen.

12 – Other Settings, Information Screens and Keyboard Operations

Power on action function setting

By using a commercially-available timer or other external device to turn this unit on, you can make this unit start playing or recording at a desired time.

1. Connect the unit to the timer so that it receives power from the timer's power output.
2. Load the current media to use for playback or recording and make the necessary settings.
3. Select **POWER ON ACTION** on the **UTILITY** page, and open the **POWER ON ACTION** screen.(see "Menu operation procedures" on page 22)

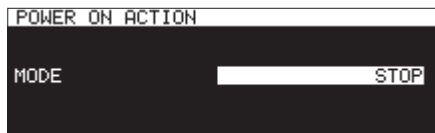

4. Select the **MODE** item, and set the power on action.

Option	Meaning
STOP (default)	When the time set on the external timer turns the unit on, the unit stays in a stopped state.
PLAY	When the time set on the external timer turns the unit on, the unit automatically starts playback.
REC	When the time set on the external timer turns the unit on, the unit automatically starts recording.

5. Confirm the setting and return to the Menu Screen.
6. Set the external timer to the desired time.
When the time set on the external timer turns the unit on, the unit automatically starts playback or recording.

CAUTION

If no media is loaded in the unit, the power on action will not function.

Adjusting the analog output

If sound distorts from an output destination device at maximum output level, you can use this unit's analog output level function, which lowers the output level, to stop distortion.

1. Select **OUTPUT LEVEL** on the **UTILITY** page to open the **OUTPUT LEVEL** screen.(see "Menu operation procedures" on page 22)



2. Set the analog output level.
Options: -14dB – 2dB (default: 0dB, 1dB increments)
3. Confirm the setting and return to the Menu Screen.

Setting the reference level

You can set the analog input and output headroom (difference between the maximum and reference levels).

1. Select **REFERENCE LEVEL** on the **PREFERENCES** page, and open the **REFERENCE LEVEL** screen.(see "Menu operation procedures" on page 22)



2. Set the reference level.

Option	Meaning
-9dB	+6dBu standard level, +15dBu maximum level
-14dB	+4dBu standard level, +18dBu maximum level
-16dB (default)	+4dBu standard level, +20dBu maximum level
-18dB	+4dBu standard level, +22dBu maximum level
-20dB	+4dBu standard level, +24dBu maximum level

3. Confirm the setting and return to the Menu Screen.

Using a USB keyboard to operate the unit

You can connect a Windows-compatible USB keyboard or numeric keypad to the **USB** port on the front of the unit, and use it to control the unit.

Various controls are possible, but it makes inputting text much more efficient.

Setting the keyboard type

Set the type of keyboard being connected.

1. Select **KEYBOARD** on the **PREFERENCES** page to open the **KEYBOARD TYPE** screen.(see "Menu operation procedures" on page 22)



2. Set it to **US** (English-language keyboard) or **JPN** (Japanese keyboard).
Options: JPN (default), US
3. Confirm the setting and return to the Menu Screen.

12 – Other Settings, Information Screens and Keyboard Operations

Using the keyboard to input names and values

You can edit and input characters for the following items in the same way as with a computer.

- Folder names(see “Creating new folders” on page 44)
- File names(see “Editing folder and file names” on page 42)
- Passwords(see “Network function settings” on page 78)
- NTP server names(see “Setting the SNTP function” on page 82)
- Mark names(see “Editing mark names” on page 76)

You can also input numbers for the following items.

- Locating to a specific time(see “Locating to a specific time” on page 77)
- User-set file names 1–3(see “Setting the file name format” on page 59)
- FTP server names(see “FTP client function settings” on page 79)
- FTP user ID(see “FTP client function settings” on page 79)
- FTP target folder names(see “FTP client function settings” on page 79)
- Timer event playback path names(see “Setting the playback area” on page 71)
- Timer event download target path names(see “Setting folders/files to use for FTP server download” on page 72)

Selecting the type of character input:

Use the Shift and Caps Lock keys to change the type of character input in the same way as with a computer.

Inputting characters:

Use the number, character and symbol keys to input characters directly.

Moving the cursor:

Use the ←/→ keys.

Use the HOME/↑ key to move the cursor to the beginning.

Use the END/↓ key to move the cursor to the end.

Deleting a character:

Delete key: delete character at cursor

Back Space key: delete character before cursor

Inserting characters:

Input the character at the desired position (default: insert mode).

If the character input mode is not set to the default insert mode, press the Insert key to switch to insert mode before inputting characters.

Correcting characters:

Press the Insert key to switch to overwrite mode, move the cursor and input the correct character.

CAUTION

- *The following symbols and punctuation marks cannot be used in text.*

¥ / : * ? " ' < > |

- *Japanese characters cannot be input.*

You can also input values on the following screens.

EDIT MARK TIME screen(see “Editing mark locations” on page 76)

IP SETUP screen(see “Network function settings” on page 78)

DNS SETUP screen(see “Network function settings” on page 78)

- When these screens are open, use the s or / (slash) key to move the cursor left and the w or Enter key to move it

right.

- On the IP SETUP and DNS SETUP screens, use the “.” (decimal point) key to move the cursor right.
- Use the ↑ or + key to increase values.
- Use the ↓ or – key to decrease values.

List of keyboard operations

In addition to inputting names, you can also use the keyboard for transport control, editing and various other operations.

The functions of buttons on the front of the unit are assigned to the keyboard as follows. Character input and control modes switch automatically according to the unit operation.

Transport operations

Keyboard key	Function
← key	Same as ◀ [A-B] button
→ key	Same as, [INPUT] button
Space bar	Same as PLAY and PAUSE [CALL] buttons
Ctrl + S key	Same as STOP button
Ctrl+R key	Same as RECORD [TRK INC] button
Ctrl + F key	Track skip (FWD)
Ctrl + B key	Track skip (REW)
↑ key	Same as turning the MULTI JOG dial right on the Home Screen (move to next mark)
↓ key	Same as turning the MULTI JOG dial left on the Home Screen (move to previous mark)

Operations on menu, browse and other screens

Keyboard key	Function
Esc key	Cancel editing, including text, and return to the Home Screen
F1 key	Open the INFORMATION screen
F2 key	Open the Menu Screen
F3 key	Open the EDIT menu
F4 key	Open the BROWSE screen
F5 key	Turn repeat playback on/off
F6 key	Turn A–B repeat playback on/off
F7 key	Turn the pitch control function on/off
F8 key	Turn the key control function on/off
F9 key	Turn the auto cue function on/off
F10 key	Turn the auto ready function on/off
F11 key	Turn the incremental playback function on/off
F12 key	Start flash loading
Shift + F5 key	Set WAV file bit length
Shift + F6 key	Open recording format screen
Shift + F7 key	Set MP3 file bit rate
Shift + F8 key	Turn automatic track function on/off
Shift + F9 key	Turn synchronized recording function on/off
Shift + F10 key	Turn sampling rate converter on/off
Shift + F11 key	Dynamics setting
Ctrl + F1 key	After flash loading completes, flash start playback of track 1

12 – Other Settings, Information Screens and Keyboard Operations

Keyboard key	Function
Ctrl + F2 key	After flash loading completes, flash start playback of track 2
Ctrl + F3 key	After flash loading completes, flash start playback of track 3
Ctrl + F4 key	After flash loading completes, flash start playback of track 4
Ctrl + F5 key	After flash loading completes, flash start playback of track 5
Ctrl + F6 key	After flash loading completes, flash start playback of track 6
Ctrl + F7 key	After flash loading completes, flash start playback of track 7
Ctrl + F8 key	After flash loading completes, flash start playback of track 8
Ctrl + F9 key	After flash loading completes, flash start playback of track 9
Ctrl + F10 key	After flash loading completes, flash start playback of track 10
Ctrl + F11 key	After flash loading completes, flash start playback of track 11
Ctrl + F12 key	After flash loading completes, flash start playback of track 12
Ctrl + C key	Turn the call function on/off
Ctrl + I key	Select the input source
Ctrl + J key	Enable jog playback mode
Ctrl + K key	Open the time skip settings screen.
Ctrl + L key	Open the lock function settings screen
Ctrl + M key	Open the MEDIA SELECT screen
Caps Lock key	Lock/unlock use of uppercase English letters
Back Space key	Delete character before cursor
Enter key	Same as pressing the MULTI JOG dial
Insert key	Insert a character at the cursor position
Home key	Same as HOME INFO button
Delete key	Delete character at cursor position
↑ key	Same as turning the MULTI JOG dial
↓ key	
← key	Same as pressing the ◀◀ [A-B] button
→ key	Same as pressing the ▶▶ [INPUT] button
Shift + ↑ key	Adjust the display contrast
Shift + ↓ key	
Ctrl + ↑ key	Adjust the pitch in ±1% increments with the pitch control function
Ctrl + ↓ key	
Ctrl + ← key	Adjust the key with the key control function
Ctrl + → key	
Number keys	Input numbers
* (asterisk) key	Enable locate time input

Numeric keypad (only transport operations)

Keyboard key	Function
. (decimal point) key	Same as STOP button
0 key	Same as PLAY and PAUSE buttons
1 key	Search backward
2 key	Search forward
3 key	Same as RECORD button
7 key	Skip to an earlier track
8 key	Skip to a later track
9 key	Same as PAUSE button
/ (slash) key	Enable jog playback mode
- key	Same as turning the MULTI JOG dial left (move to previous mark)
+ key	Same as turning the MULTI JOG dial right (move to next mark)
Enter key	Same as pressing the MULTI JOG dial (add/remove mark)

NOTE

Press the key for the desired editing function on the keyboard when the **BROWSE** screen is open.

Example: using the **DELETE** function

Press the F4 key to open the **BROWSE** Screen.

Use the ↑/↓/←/→ keys to select the file you want to delete.

Press the ENTER button to open the **BROWSE** screen pop-up menu.

Use the ↑/↓ keys to select the **DELETE** item.

Press the Enter key to open a confirmation message on the display. Press the Enter key again.

When a reconfirmation message appears, press and hold the Enter key again.

12 – Other Settings, Information Screens and Keyboard Operations

Viewing media information

You can view information about the current medium.

1. Select **MEDIA INFORMATION** on the **MEDIA** page to open the **MEDIA INFORMATION** screen.(see “Menu operation procedures” on page 22)

You can view information about the current medium, and check its total capacity, open space and other use conditions.

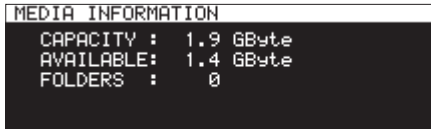

2. Press the **MULTI JOG** dial to return to the menu screen.

Restoring factory default settings

You can restore the various settings stored in the backup memory of the unit to their factory default values.

Use the following menu procedures to do so.

1. Select **FACTORY PRESET** on the **SYSTEM 1** page.(see “Menu operation procedures” on page 22)
2. Press the **MULTI JOG** dial.
A confirmation pop-up message appears.



NOTE

*Press the **MENU [JOG]** button to cancel execution.*

3. Press the **MULTI JOG** dial again to restore the factory default settings.

A “**READING MEDIA...**” pop-up will appear. After it completes, the Menu Screen will reopen.

Saving and loading user settings

This unit can store three sets of user setting data in its built-in memory.

Saving user settings

This unit can save user setting data in its built-in memory.

1. Select **SAVE USER PRESET** on the **SYSTEM 1** page to open the **SAVE USER PRESET** screen.(see “Menu operation procedures” on page 22)

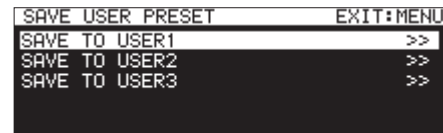

2. Select **SAVE TO USER1 – SAVE TO USER3** as the destination to save the settings, and press the **MULTI JOG** dial.
A confirmation pop-up message appears.

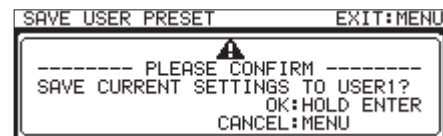

3. When the confirmation message is open, press and hold the **MULTI JOG** dial to begin saving the user settings to the built-in memory.
After saving completes, the **SAVE USER PRESET** screen reopens.

Loading user settings

This unit can load saved user settings from its built-in memory.

1. Select **LOAD USER PRESET** on the **SYSTEM 1** page to open the **LOAD USER PRESET** screen.(see “Menu operation procedures” on page 22)



2. Select **LOAD USER1 – LOAD USER3** to load the settings in that preset, and press the **MULTI JOG** dial.
A confirmation pop-up message appears.



3. When the confirmation message is open, press and hold the **MULTI JOG** dial to begin loading the user settings from the built-in memory. After saving completes, the **LOAD USER PRESET** screen reopens.

12 – Other Settings, Information Screens and Keyboard Operations

Exporting/importing system backup data

You can export system backup data from the unit's built-in memory to an SD card or USB flash drive loaded in the unit. You can also import this data.

1. Select **SYSTEM BACKUP** on the **SYSTEM 1** page to open the **SYSTEM BACKUP** screen.(see “Menu operation procedures” on page 22)

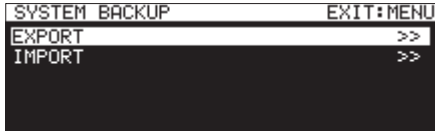

2. Select whether to export or import system backup data to or from the SD card or USB flash drive.

EXPORT: Export system backup data to the SD card or USB flash drive.

IMPORT: Import system backup data from the SD card or USB flash drive.

3. Press the **MULTI JOG** dial.

A confirmation pop-up message will appear.



Pop-up message when set to **EXPORT**



Pop-up message when set to **IMPORT**

4. When the confirmation message is open, press and hold the **MULTI JOG** dial to begin exporting to or importing from the SD card or USB flash drive.

When exporting/importing ends, the **SYSTEM BACKUP** screen reopens.

- The following setting items are saved and loaded with system backup data.

Screen name	Page name	Setting item	
Home Screen		Time counter display mode	
		Solo selection channel	
LOCK SETUP screen		All settings	
Menu Screen	PLAY 1 page	All settings	
	PLAY 2 page	All settings	
	PLAY 3 page	All settings	
	REC 1 page	All settings	
	REC 2 page	All settings	
	REC 3 page	All settings	
	REC 4 page	All settings	
	REC 5 page	All settings	
	TIMER EVENT page	TIMER EVENT item	
	NETWORK 1 page	All settings	
	FTP CLIENT page		TARGET FTP SERVER screen SERVER ADDRESS and USER ID items
			FTPS MODE item
			TARGET FOLDER NAME item
			AUTO UPLOAD item
	SNTP page	All settings	
UTILITY page	All settings		
PREFERENCES page	All settings		
REMOTE page	All settings		

12 – Other Settings, Information Screens and Keyboard Operations

Checking the firmware version

You can check the version of the system firmware used by the unit.

1. Select **VERSION** on the **SYSTEM 2** page to open the **VERSION** screen.(see "Menu operation procedures" on page 22)

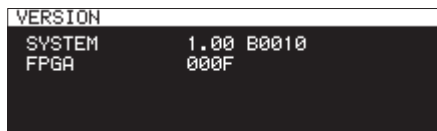

On the **VERSION** screen, information is shown about the system firmware version, build number and FPGA firmware version.

2. Press the **MENU [JOG]** button to return to the Menu Screen.

Firmware update procedures

1. Download the latest firmware from the TEAC Global Site (<http://teac-global.com/>). Decompress the downloaded file if it is in ZIP format or another compressed file type.
2. Copy the downloaded firmware to the root level of the medium.
3. Load the medium prepared in step 2 in an SD card slot or the USB port on the front of the unit.
4. Set that medium as the current medium on the **MEDIA SELECT** screen.
5. Select **UPDATE** on the **SYSTEM 2** page to open the **FIRMWARE UPDATE** screen.(see "Menu operation procedures" on page 22)



SYSTEM item

Update the unit's firmware.

FPGA item

Update the unit's FPGA.

RC-SS150 item

Update the firmware of a **TASCAM RC-SS150** remote control.

6. Select the item to update, and press the **MULTI JOG** dial. After the medium and firmware update file have been verified, the following screen will appear.



NOTE

- The screen above shows a list of firmware update files in the root folder of the current medium. The firmware copied in step 2 above should also be shown. No Update File is shown if no update file is in the directory.
- A maximum of five lines of firmware can be shown at the same time. If there are more files than can be shown on the display at once, use the **MULTI JOG** dial to scroll the list.
- The screen shown above is an example. The actual appearance will differ.

7. Select the firmware update to use. The screen shown below will appear.

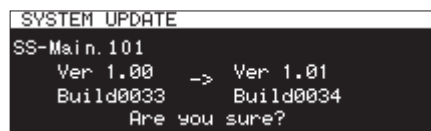

The number of the current version is shown on the left and the update version is shown on the right.

NOTE

The screen shown above is an example. The actual appearance will differ.

8. Press the **MULTI JOG** dial to start updating.

CAUTION

- Be careful not to let the power be interrupted during the update.
- If the power is interrupted during the update, the unit might become unstartable.

9. When the update completes, the following message will appear.

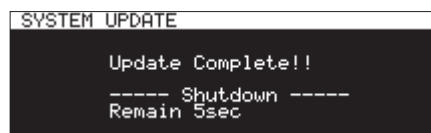

10. When the unit automatically turns off after the message appears, turn it on again.
11. Confirm that the latest firmware is being used. This completes the update procedure.(see "Checking the firmware version" on page 89)
12. Delete the firmware update file from the medium.

13– Using the Remote Control Connectors

Using the RS-232C connector

Using the **RS-232C** connector (9-pin D-sub RS-232C standard) on the back of the unit, this unit can be operated by a computer or other external device by serial control. In addition, flash starting by remote control is possible if a TASCAM RC-SS150 (sold separately) is connected.

Select **RS-232C** on the **REMOTE** page to open the **RS-232C** screen. (see “Menu operation procedures” on page 22)



Setting the transmission speed (baud rate)

Select **BAUD RATE**, and set the transmission speed (baud rate).

Options: 4800bps, 9600bps, 19200bps, 38400bps, 57600bps (default)

Setting the parity bit

Select **PARITY BIT**, and set whether or not there is a parity bit.

Options: NONE (none, default value), EVEN (even), ODD (odd)

Setting the stop bit

Select **STOP BIT**, and set the stop bit.

Options: 1 (default), 2

Set the data length

Select **DATA LENGTH**, and set the data length.

Options: 7bit, 8bit (default)

NOTE

- The 9 pin of this unit's RS-232C connector is used to supply 12V power to the TASCAM RC-SS150. Do not use it to supply power to any other device. The 9 pin of ordinary computer RS-232C connectors is unused, so commercially-available RS-232C cables can be used for connection.
- For information about this unit's RS-232C command protocol, please contact the TASCAM customer support service.

Using a footswitch (TASCAM RC-3F)

You can use a TASCAM RC-3F footswitch (sold separately) connected to the **REMOTE** jack on the front of this unit to control it.



TASCAM RC-3F
(sold separately)

Setting up the footswitch

1. Select **RC-3F MODE** on the **REMOTE** page to open the **RC-3F MODE** screen. (see “Menu operation procedures” on page 22)



2. Select one of the three pedal assignment modes.

Option	Meaning
MODE1 (default)	This mode is optimal for recording minutes of meetings, for example.
MODE2	This mode provides basic transport remote control.
MODE3	Use this mode for the pitch control function.

3. Confirm the setting and return to the Menu Screen.

Using the footswitch

Press the pedals of the footswitch to use the operations assigned to them by the **RC-3F MODE** item.

Footswitch pedal assignments

MODE	Footswitch		
	L (press)	C (press)	R (press)
	L (press and hold)	C (release)	R (press and hold)
1	⏪	PLAY	⏩
	⏮	PAUSE/STOP	⏭
2	⏪	PLAY/PAUSE	⏩
	⏮	---	⏭
3	PITCH (-) 1% increments	PLAY/PAUSE	PITCH (+) 1% increments
	---	---	---

14 – Messages

The following is a list of messages that appear in pop-up windows.

Refer to this list if one of these pop-up messages appears on the SS-R250N and you want to check the meaning or determine a proper response.

Message	Meaning	Note
Backup REC is not available. {MM is not available}	Backup recording is disabled because the medium cannot be used.	MM = SD1, SD2 or USB
Backup REC is not available. MM formatting not optimal for Recording.	Backup recording is disabled because the medium has not been formatted by this unit and cannot be guaranteed to properly record. Format it with this unit before use.	MM = SD1, SD2 or USB
Cannot add timer event. Timer event limit reached.	The limit has been reached so no more timer events can be added.	
Cannot change while playing.	This setting cannot be changed during playback.	
Cannot change while recording.	This setting cannot be changed when recording.	
Cannot Copy. "ffffffff" already exist in current folder	You tried to copy a file to the current folder. The current folder, however, already contained a file with the same name as the file being copied.	ffffffff = file name
Cannot Copy File. "ffffffff" already exist in Destination.	The selected file already exists in the copy destination, so it cannot be copied.	ffffffff = file name
Cannot Copy Folder. "ffffffff" already exist in Destination.	The selected folder already exists in the copy destination, so it cannot be copied.	ffffffff = folder name
Cannot Copy for Insert. "ffffffff" already exist in current Folder.	The selected file already exists in the current folder, so it cannot be inserted.	ffffffff = file name
Cannot Copy. Source folder and Destination folder is same.	The copy source folder and destination folder are the same, so copying is not possible.	
Cannot Copy. Destination folder is sub-folder of source folder.	The copy destination folder is a subfolder of the copy source folder, so copying is not possible.	
Cannot create new file/folder. Media Full.	There is no open space on the medium, so a new file or folder cannot be created.	
Cannot create new mark point. Mark point already exists at the same timestamp.	You are trying to create a mark where one already exists. A time position cannot have more than one mark.	
Cannot edit this mark point. Mark point already exists at the same timestamp.	The market cannot be edited because another mark already exists at that time.	
Cannot Edit read-only file	The file is read only and cannot be edited.	
Cannot execute combine. Combine file size is over XXX.	The file size after combination would exceed 2 GB, so combining is not possible.	
Cannot execute combine. Media Full.	The medium does not have enough open space so combining is not possible.	
Cannot execute. Media Full.	The medium does not have enough open space so execution is not possible.	
Cannot increment Track Interval is too short.	Either you pressed the RECORD [TRK INC] button within the first 4 seconds of recording, or writing to the medium was too slow, so starting to record a new track is not possible.	
Cannot increment Track System limit reached. Please create new Folder.	The number of files in the folder or total number of files and directories, for example, is too great, so starting to record a new track is not possible.	
Cannot make more than 1000 folders.	The maximum number of folders has already been reached, so a new folder cannot be created.	

14 – Messages

Message	Meaning	Note
Cannot RECORD (Internal state error)	Recording cannot start for some reason.	If this occurs frequently, prepare information about it including the operation steps that cause it, and contact the TASCAM customer support service.
Cannot record. Media full.	The medium does not have enough open space, so recording cannot be started.	
Cannot record. System limit.	The number of files in the folder or total number of files and directories, for example, is too great, so starting to record is not possible.	
Cannot record. Track limit.	The maximum number of tracks have already been recorded, so recording cannot be started. Change the folder.	
Cannot RECORD Entry 100 is already assigned. Please create new Playlist or clear Entry 100.	The number of playlist entries would exceed 100. Create a new playlist or clear the 100th entry in the playlist.	
Cannot set Mark point limit reached.	Only 99 marks can be added.	
Cannot set Mark point in read-only file.	The file is read only, so marks cannot be added.	
COPY FAILED	The file or folder could not be copied.	
Delete failed	The file or folder could not be deleted.	
DEVICE ERROR	Mounting the medium failed.	
DIN ERROR Digital input is illegal.	An error occurred with the digital input selected for the digital signal.	
(error) INFO WRITING	An error occurred while writing data.	
File Copy Failed.	Copying a file failed.	
Folder Copy Failed.	Copying a folder failed.	
Format failed.	The media formatting failed.	
Formatting not optimal.	The format of the medium is not supported, so recording cannot be started.	Use this unit's format function to format the media.(see "Preparing SD cards and USB flash drives for use" on page 28)
Make Playlist failed	Creating a playlist failed.	
No Call Point	The call point has not been set.	
No Mark Point	No mark points have been added.	
Not recommended type for Re- cording.	The medium is not suitable for recording, so recording cannot be started.	
Operation failed. folder limit	The maximum number of folders has already been reached, so the operation cannot be executed.	
Operation failed. long name	The path name exceeds the character number limit, so the operation cannot be executed.	This occurs if the full path name is 255 characters or longer.
Operation failed. playlist limit	The maximum number of playlists has already been reached, so the operation cannot be executed.	
Operation failed. XXXXXXXXXX	The operation could not be executed for some reason.	If this occurs frequently, prepare information about it including the operation steps that cause it, and contact the TASCAM customer support service.
Play Error Buffer underrun	Data reading processes could not keep up during playback.	
Play Error.	A playback error occurred	
RECORD Error	An error occurred during recording.	

Message	Meaning	Note
RECORD Error Buffer overflow.	The recording buffer became full during recording. Writing to the medium could not keep up.	Since the writing performance of the medium has declined, use the ERASE FORMAT function or use a different medium.(see “Preparing SD cards and USB flash drives for use” on page 28)
RECORD stopped. Media Full.	The medium did not have enough capacity, so recording stopped.	
RECORD stopped. System limit.	Recording stopped because the total number of files, folders and other items inside the folder would have exceeded 999.	
Save Failed.	Saving the file failed.	
SD Card Locked	The SD card is locked.	
SD Card Locked Cannot Record/Edit	Since the SD card is locked, recording and editing are not possible.	
This name already exists.	A folder or file with the same name already exists.	
There is no entry.	Playback is not possible because the playlist has no entries. Select a playlist that has entries or assign entries to this one.	
There is no track	Playback is not possible because there are no files.	
Timer Event nn (Download) Failed	The download timer event numbered nn failed.	nn = timer event number
Unsupported File too many tracks	You tried to play a file with more tracks than are supported. Or, you tried to add too many to a playlist.	
Unsupported Fs.	You tried to play a file with a sampling frequency that is not supported. Or, you tried to add one to a playlist.	
unsupported type	The media is not a supported type (not DMA compatible), so it cannot be used.	

15 – Troubleshooting

If you are having trouble with the operation of this unit, please try the following before seeking repair.

If these measures do not solve the problem, please contact the store where you purchased this unit or TASCAM customer support service.

The unit will not turn on.

- Confirm that the power plug and other connectors are inserted completely.

The medium is not recognized.

- Confirm that the SD card or USB flash drive is loaded completely.
- Stop playback or recording once.

The unit does not function.

- Confirm that the lock function is not on.

Playback is not possible.

- If you are trying to play a WAV file, confirm that it uses a sampling frequency (44.1/48/96kHz) and a bit depth (16/24-bit) that are supported by this unit.
If you are trying to play an MP3 file, confirm that the bit rate is supported by this unit.

No sound is output.

- Check connections with the monitoring system again. Check the volume of the amplifier as well.

Recording is not possible.

- If you are using an external device, check the connection again.
- Adjust the recording levels.
- If there is not enough room on the medium, delete unnecessary data to increase the amount of open space or change the medium.
- If the total number of files, folders and other items inside the recording folder is great, change the recording folder.

Changed settings are forgotten.

- This unit backs up the settings every time they are changed. Backup can fail depending on when the power is turned off. Do not turn the power off immediately after changing a setting.

There is noise.

- Confirm that the connection cables do not have contact issues.

"Name Full" appears when editing a name.

- Due to system limitations, 255 is the maximum number of characters (half-width) that can be used in file and folder names as well as in other text fields. Moreover, the full path on the BROWSE screen is limited to 255 characters. This limit includes all the folder, subfolders and file names along with the ¥ symbols that divide them.

The RC-10 remote control does not function.

- Confirm that a battery is installed and has not died.

General

Recording media

SD cards (512MB–2GB)
SDHC cards (4GB–32GB)
SDXC cards (64GB–128GB)
USB flash drives (512MB–64GB)

Recording and playback file formats

MP3: 44.1/48kHz, 64/128/192/256/320kbps
WAV: 44.1/48/96 kHz, 16/24-bit

Number of channels

2 channels (stereo)
1 channel (mono)

Input and output

Analog audio input and output ratings

Analog input (unbalanced) jacks

Connectors: RCA pin jacks
Rated input level: -10 dBV (0.316 Vrms)
Maximum input level: +6 dBV (2.0 Vrms)
Input impedance: 10 k Ω or higher

Analog input (balanced) jacks

Connectors: XLR-3-31 (1: GND, 2: HOT, 3: COLD)
For line
Nominal input level:
+4dBu (1.23Vrms, when Ref.Level set to other than -9dBFS)
+6dBu (1.55Vrms, when Ref. Level set to -9dBFS)
Maximum input level (switchable):
+15dBu (4.36Vrms, Ref. Level: -9dBFS)
+18dBu (6.16Vrms, Ref. Level: -14dBFS)
+20dBu (7.75Vrms, Ref. Level: -16dBFS)
+22dBu (9.76Vrms, Ref. Level: -18dBFS)
+24dBu (12.28Vrms, Ref. Level: -20dBFS)
Input impedance: 10 k Ω or higher

For mic (phantom power supported)

Maximum input level: +4 dBu (1.23 Vrms)
Minimum input level: -70 dBu (245 μ Vrms) or higher
Input impedance: 2.2 k Ω or higher

Analog output (unbalanced) jacks

Connectors: RCA pin jacks
Rated output level: -10 dBV (0.316 Vrms)
Maximum output level: +6 dBV (2.0 Vrms)
Output impedance: 200 Ω

Analog output (balanced) jacks

Connectors: XLR-3-32 (1: GND, 2: HOT, 3: COLD)
Nominal output level:
+4dBu (1.23Vrms, when Ref.Level set to other than -9dBFS)
+6dBu (1.55Vrms, when Ref. Level set to -9dBFS)
Maximum output level (switchable):
+15dBu (4.36Vrms, Ref.Level: -9dBFS)
+18dBu (6.16Vrms, Ref.Level: -14dBFS)
+20dBu (7.75Vrms, Ref.Level: -16dBFS)
+22dBu (9.76Vrms, Ref. Level: -18dBFS)
+24dBu (12.28Vrms, Ref.Level: -20dBFS)
Output impedance: 200 Ω

Phones jack

Connector: 6.3mm (1/4") standard stereo jack
Maximum output level: 45 mW + 45 mW or higher (THD+N 0.1% or less, into 32 Ω load)

Digital audio input/output ratings

Digital input (AES/EBU) jack

Connector: XLR-3-31
Input impedance: 110 Ω
Format: AES3-2003/IEC60958-4 (AES/EBU)
Supported sampling frequencies: 44.1, 48, 96 kHz
When SRC ON, 32kHz–192kHz can be received

Digital input (S/PDIF) jack

Connector: RCA pin jack
Format: IEC60958-3
Supported sampling frequencies: 44.1, 48, 96 kHz
When SRC ON, 32kHz–192kHz can be received

Digital output (AES/EBU) jack

Connector: XLR-3-32
Output impedance: 110 Ω
Format: AES3-2003/IEC60958-4 (AES/EBU)
Supported sampling frequencies: 44.1, 48, 96 kHz

Digital output (S/PDIF) jack

Connector: RCA pin jack
Format: IEC60958-3

16 – Specifications

Control input/output

Remote jack

Connector: 2.5mm (3/32") TRS jack (for TASCAM RC-3F or RC-20 (sold separately))

USB port

Connector: 4-pin USB A-type
Protocol: USB 2.0 HIGH SPEED (480 Mbps)

RS-232C connector

D-sub 9-pin

Parallel connector

D-sub 25-pin
Maximum input voltage: +5.5 V
High level minimum input voltage: +2.31 V
Low level maximum input voltage: +0.99 V
Output format: Open collector (10 Ω output impedance, 20V withstand voltage, 35mA maximum)
Low level maximum output voltage: 0.5 V
+5V power supply maximum supplied current: 100mA

Ethernet connector

Connector: RJ45
Compatible standard: 100BASE-TX

Audio performance

Frequency response

20 Hz – 20 kHz: ± 0.5 dB (LINE IN or MIC IN to LINE OUT, $F_s = 44.1/48$ kHz, JEITA)

20 Hz – 40 kHz: +0.5/-3 dB (LINE IN or MIC IN to LINE OUT, $F_s = 96$ kHz, JEITA)

Distortion

0.002% or less (LINE IN to LINE OUT, Ref. Level: -16dBFS, $F_s = 44.1/48/96$ kHz, JEITA)

S/N ratio

106 dB or more (LINE IN to LINE OUT, $F_s = 44.1/48/96$ kHz, JEITA)

Dynamic range

106 dB or more (LINE IN to LINE OUT, $F_s = 44.1/48/96$ kHz, JEITA)

Crosstalk between channels

100 dB or more (LINE IN to LINE OUT, $F_s = 44.1/48/96$ kHz, JEITA)

Equivalent input noise (EIN)

-125 dBu or less (150 Ω , 20kHz LPF, A-weighted)

Note: JEITA indicates compliance with JEITA CP-2150

Other

Power

AC100-240V, 50-60 Hz

Power consumption

20 W

Dimensions

482.6 × 45 × 300.5 mm (W x H x D)

Weight

2.9 kg

Operating temperature range

5°C – 35°C

Dimensional drawings

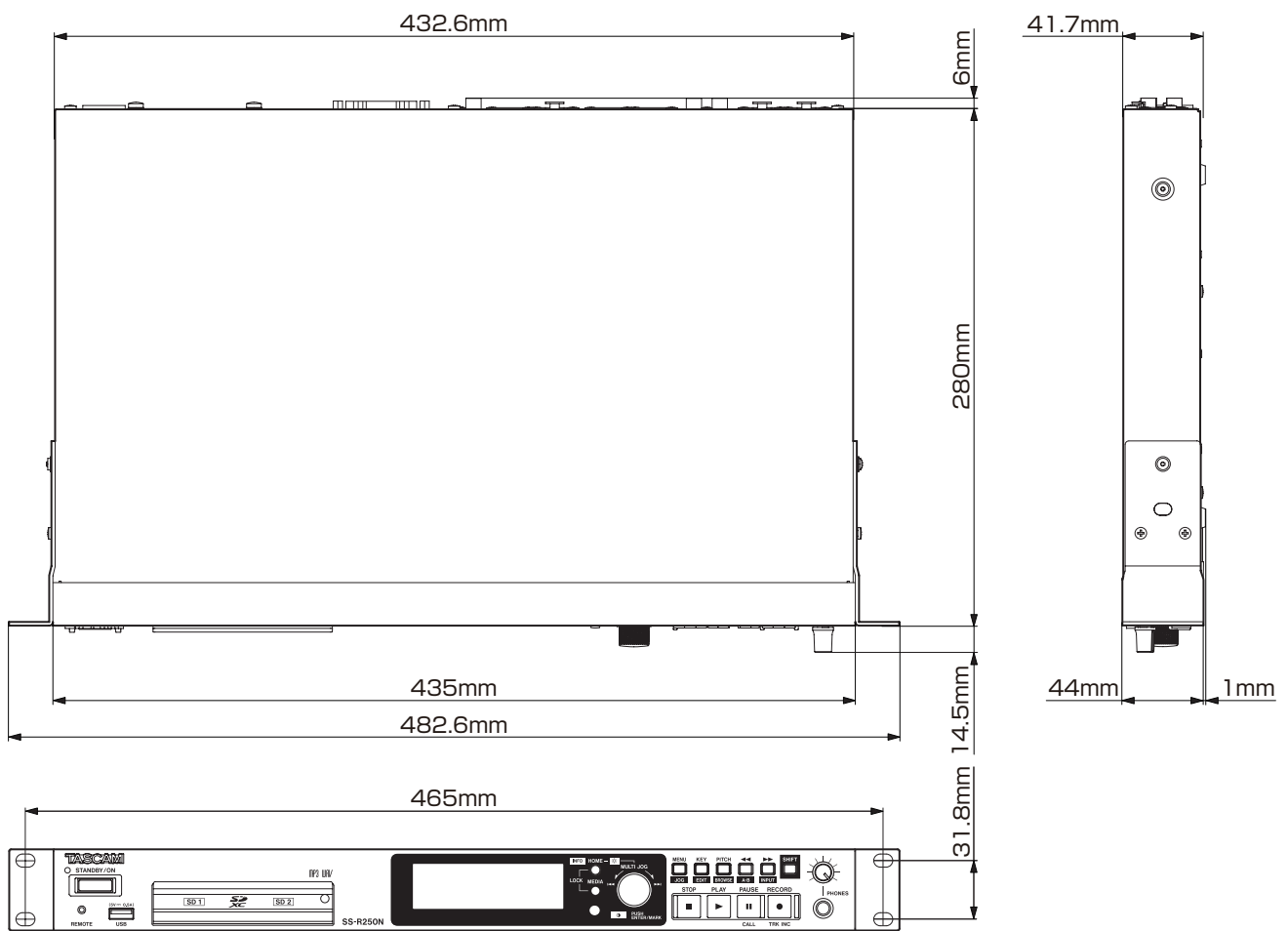

- Illustrations in this manual might differ in part from the actual product.
- Specifications and external appearance might be changed without notification to improve the product.

16 - Specifications

Block diagrams

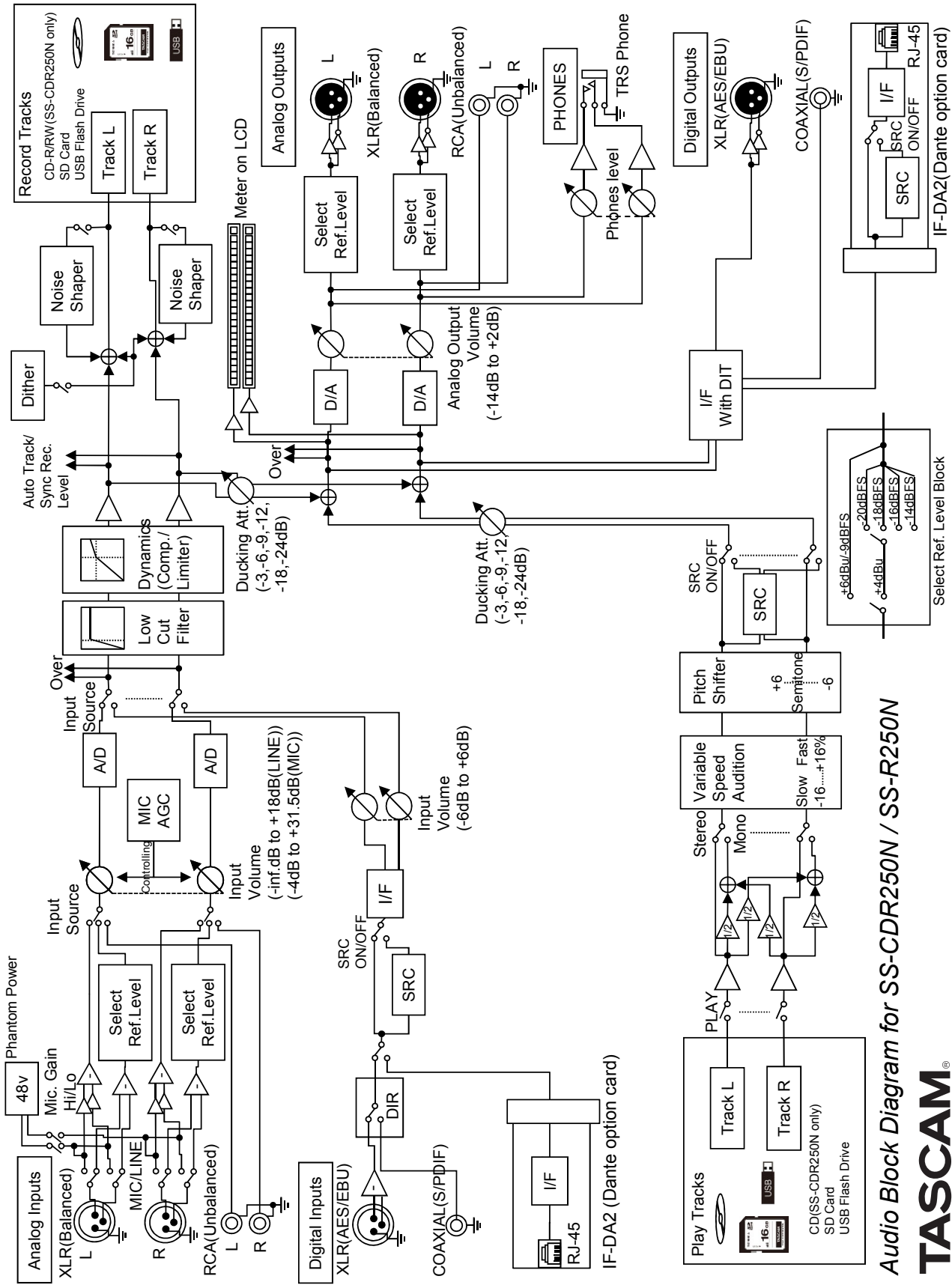

Audio Block Diagram for SS-CDR250N / SS-R250N

TASCAM

WARRANTY

< In the United States >

This warranty gives you specific legal rights and you may also have other rights which vary from state to state. This warranty is only valid within the country the unit was originally purchased.

WHAT IS AND IS NOT COVERED

Except as specified below, this warranty covers all defects in materials and workmanship in this product. The following are not covered by the warranty:

1. **Damage to or deterioration of the external cabinet.**
2. **Damages resulting from accident, misuse, abuse or neglect.**
3. **Damage resulting from failure to perform basic daily maintenance and/or calibration or otherwise resulting from failure to follow instructions contained in your owner's manual.**
4. **Damage occurring during shipment of the product. (Claims must be presented to the carrier)**
5. **Damage resulting from repair or attempted repair by anyone other than TEAC or an authorized TASCAM service station.**
6. **Damage resulting from causes other than product defects, including lack of technical skill, competence, or experience of the user.**
7. **Damage to any unit which has been altered or on which the serial number has been defaced, modified or is missing.**

WHO MAY ENFORCE THE WARRANTY

This warranty may be enforced only by the original purchaser. This warranty is not valid if the product was purchased through an unauthorized dealer.

LENGTH OF WARRANTY

All parts except heads and disk drives are warranted for one (1) year from the date of original purchase. Heads and disk drives are warranted to ninety (90) days from date of original purchase. Labor is warranted for ninety (90) days from date of original purchase.

WHAT WE WILL PAY FOR

We will pay all labor and material expenses for items covered by the warranty. Payment of shipping charges is discussed in the next section of this warranty.

HOW YOU CAN GET WARRANTY SERVICE

Your unit must be serviced by an authorized TASCAM service station in the United States. (This warranty is not enforceable outside the U.S.) If you are unable to locate an authorized TASCAM service station in your area, please contact us. We either will refer you to an authorized service station or instruct you to return the unit to the factory. Whenever warranty service is required, you must present a copy of the original dated sales receipt from an Authorized TASCAM Dealer. You must pay any shipping charges if it is necessary to ship the product to service. However, if the necessary repairs are covered by the warranty, we will pay return surface shipping charges to any destination within the United States.

LIMITATION OF IMPLIED WARRANTIES

Any implied warranties, INCLUDING WARRANTIES OF MERCHANTABILITY AND FITNESS FOR A PARTICULAR PURPOSE, are limited in duration to the length of this warranty.

EXCLUSION OF DAMAGES

TEAC's liability for any defective product is limited to repair or replacement of the product, at TEAC's option. TEAC shall not be liable for:

1. **Damages based upon inconvenience, loss of use of the product, loss of time interrupted operation or commercial loss; or**
2. **Any other damages, whether incidental, consequential or otherwise.**

Some states do not allow limitations on how long an implied warranty lasts and/or do not allow the exclusion or limitation of incidental or consequential damages, so the above limitations and exclusions may not apply to you.

To locate an Authorized Service Center in Your Area

CALL 1-800-447-8322

< Europe >

This product is subject to the legal warranty regulations of the country of purchase. In case of a defect or a problem, please contact the dealer where you bought the product.

Ce produit est sujet aux réglementations concernant la garantie légale dans le pays d'achat. En cas de défaut ou de problème, veuillez contacter le revendeur chez qui vous avez acheté le produit.

Dieses Gerät unterliegt den gesetzlichen Gewährleistungsbestimmungen des Landes, in dem es erworben wurde. Bitte wenden Sie sich im Gewährleistungsfall an den Händler, bei dem sie das Gerät erworben haben.

Questo apparecchio è conforme alle norme sulla garanzia vigenti nel rispettivo Paese in cui esso è stato acquistato. Si prega di rivolgersi al proprio commerciante, presso il quale è stato acquistato l'apparecchio, nel caso in cui si voglia richiedere una prestazione in garanzia.

Las condiciones de garantía de este aparato están sujetas a las disposiciones legales sobre garantía del país en el que ha sido adquirido. En caso de garantía, debe dirigirse al establecimiento donde adquirió el aparato.

< In other countries/areas >

This warranty gives you specific legal rights, and you may also have other rights that vary by country, state or province.

If you have a warranty claim or request, please contact the dealer where you bought the product.

该保证书赋予了顾客特定的合法权利，并且因国家、州或省等地域的不同，顾客可能拥有其他权利。如需申请或要求保修，请与购买本产品的销售店进行联系。

If you require repair services for your **TASCAM** equipment, please contact the dealer where the product was purchased from or the **TASCAM** Distributor in your country. A list of **TASCAM** Distributors can be found on our website at: <http://teac-global.com/>

TASCAM

TEAC CORPORATION

Phone: +81-42-356-9143
1-47 Ochiai, Tama-shi, Tokyo 206-8530 Japan

<https://tascam.jp/jp/>

TEAC AMERICA, INC.

Phone: +1-323-726-0303
1834 Gage Road, Montebello, California 90640 USA

<http://tascam.com/>

TEAC MEXICO, S.A. de C.V.

Phone: +52-55-5010-6000
Río Churubusco 364, Colonia Del Carmen, Delegación Coyoacán, CP 04100, México DF, México

<http://teacmexico.net/>

TEAC UK Ltd.

Phone: +44-8451-302511
2 Huxley Road, Surrey Research Park, Guildford, GU2 7RE, United Kingdom

<http://tascam.eu/>

TEAC EUROPE GmbH

Phone: +49-611-71580
Bahnstrasse 12, 65205 Wiesbaden-Erbenheim, Germany

<http://tascam.eu/>

TEAC SALES & TRADING(SHENZHEN) CO., LTD

Phone: +86-755-88311561~2
Room 817, Block A, Hailrun Complex, 6021 Shennan Blvd., Futian District, Shenzhen 518040, China

<http://tascam.cn/>

Printed in China

WARRANTY

Model/Modèle/Modell
Modello/Modelo/型号

SS-R250N

Serial No./No de Série/Seriennummer
Numero di serie/Número de serie/序列号

Sample

Date of purchase/Date de l'achat/Datum des Kaufs
Data dell'acquisto/Fecha de compra/购买日期

TASCAM

<http://teac-global.com/>

Owner's name/Nom du possesseur/Name des Eigentümers
Nome del proprietario/Nombre del propietario/顾客姓名

Address/Adresse/Adresse
Indirizzo/Dirección/顾客地址

Dealer's name/Nom du détaillant/Name des Händlers
Nome del commerciante/Nombre del establecimiento/销售店名

Dealer's address/Adresse du détaillant/Adresse des Händlers
Indirizzo del commerciante/Dirección del establecimiento/销售店地址