



iKlip[®] GO

Compact selfie stick with Bluetooth shutter

USER MANUAL

Table of Contents

Contents	2
English	3
iKlip GO	3
Register your iKlip GO	3
Using iKlip Go	4
Using the Bluetooth shutter	8
Compatible Devices	10
Specifications	10
Warranty	10
Support and more info	10

iKlip GO

Thank you for purchasing iKlip GO.

Your package contains:

- iKlip GO
- Wrist hand strap
- Device holder
- *Bluetooth shutter
- Quick Start Guide
- Registration Card

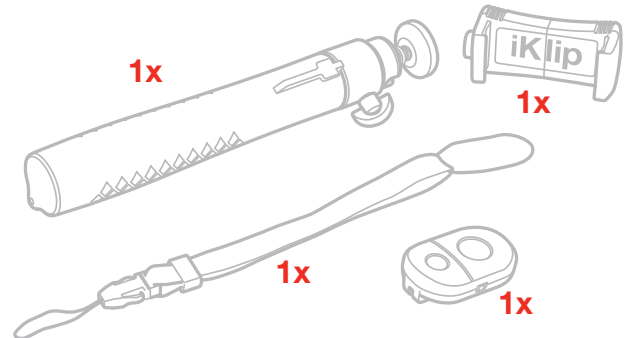

iKlip Go is a fancy selfie stick developed to offer universal fitting with most smartphones on the market and a glamour look and feel.

It consist in a soft-rubber handle for the maximum ergonomics, an aluminum telescopic pole, an Xpand support and a BT shutter (perfectly integrated on the handle design). It can be extended up to 74cm and, when folded, it is less than 17cm.

It maintain some of the features that make of iKlip Grip and Grip Pro a market hit: In fact, it has a multipurpose mount that fits a wide number of smartphones thanks to the expandable support (iKlip Xpand mini technology). iKlip Go accepts any smartphone with or without a case with a screen size of 3.5" to 6". The phone is locked in place by the expandable support while you can hold the handle for one-handed control.

Register your iKlip GO

By registering, you can access technical support, activate your warranty and receive free JamPoints™ which will be added to your account. JamPoints™ allow you to obtain discounts on future IK purchases! Registering also keeps you informed of all the latest software updates and IK products.

Register at: www.ikmultimedia.com/registration

Using iKlip Go

1. Mount the Xpand holder on the threaded ball at the top of the pole. Alternatively you can mount any camera with standard 1/4"-20 female thread.

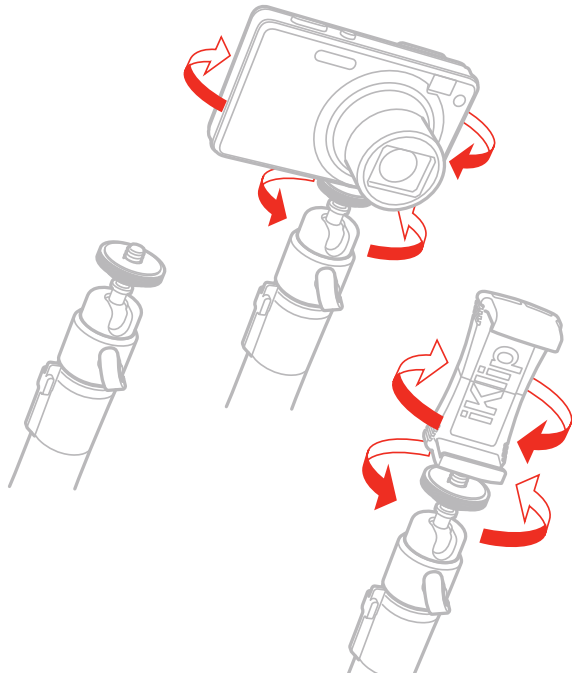

2. Fit your preferred smartphone and orientate it by operating the side key.

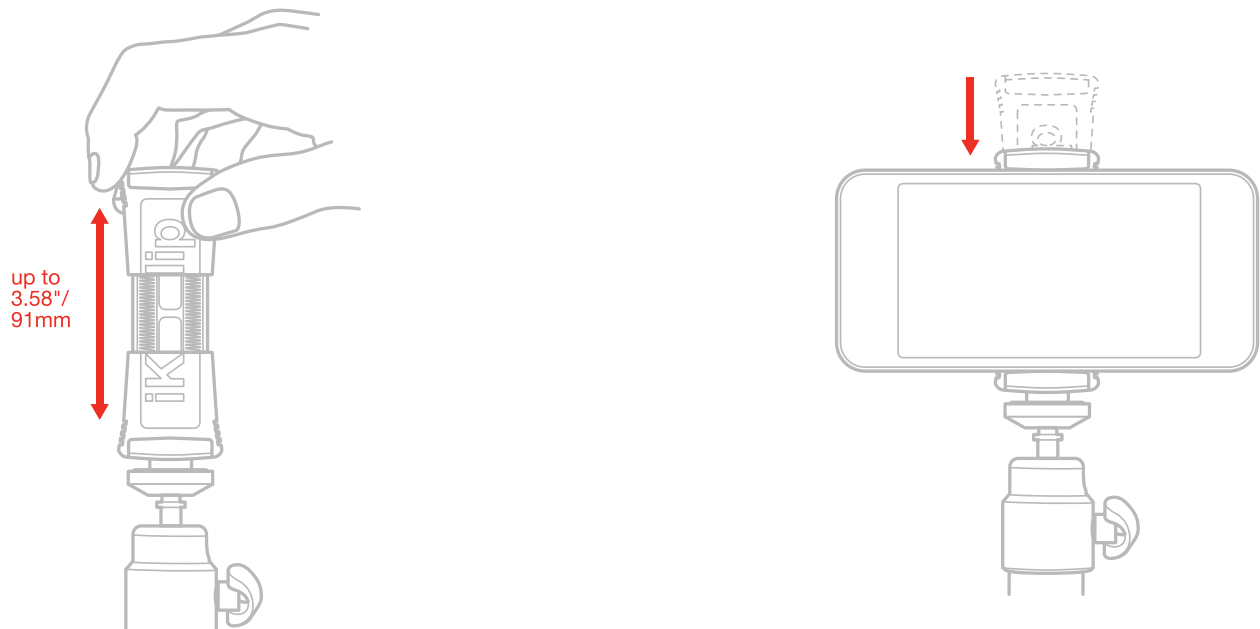

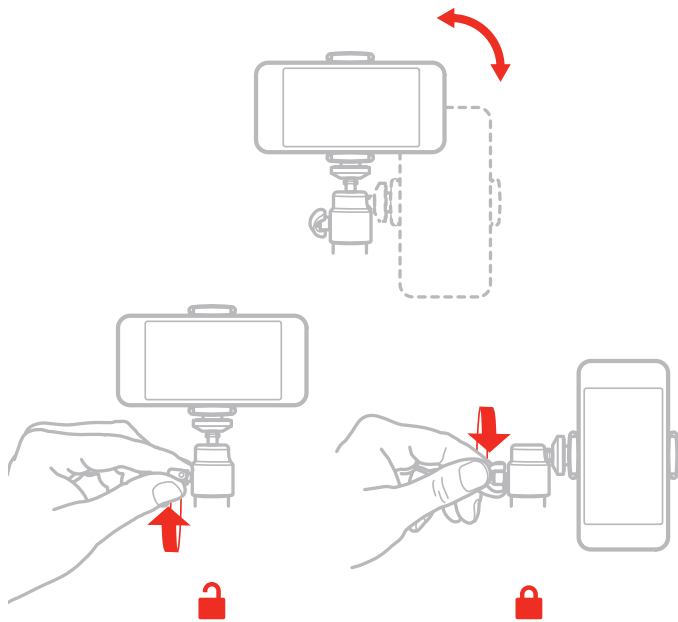

3. Now you are ready to take your pictures

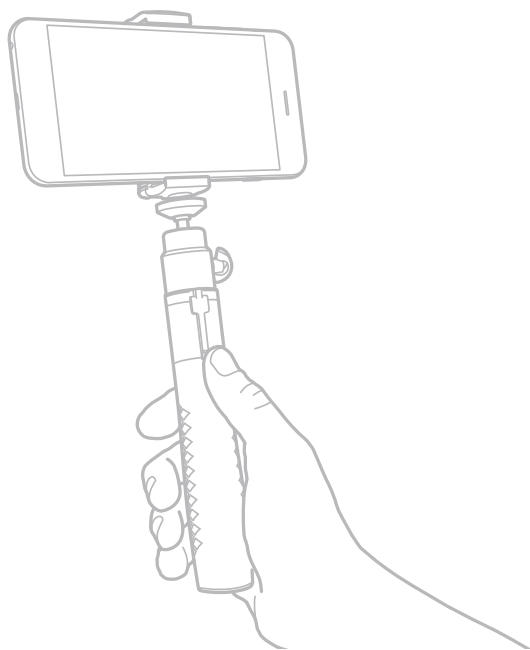

4. You can extend the telescopic pole.

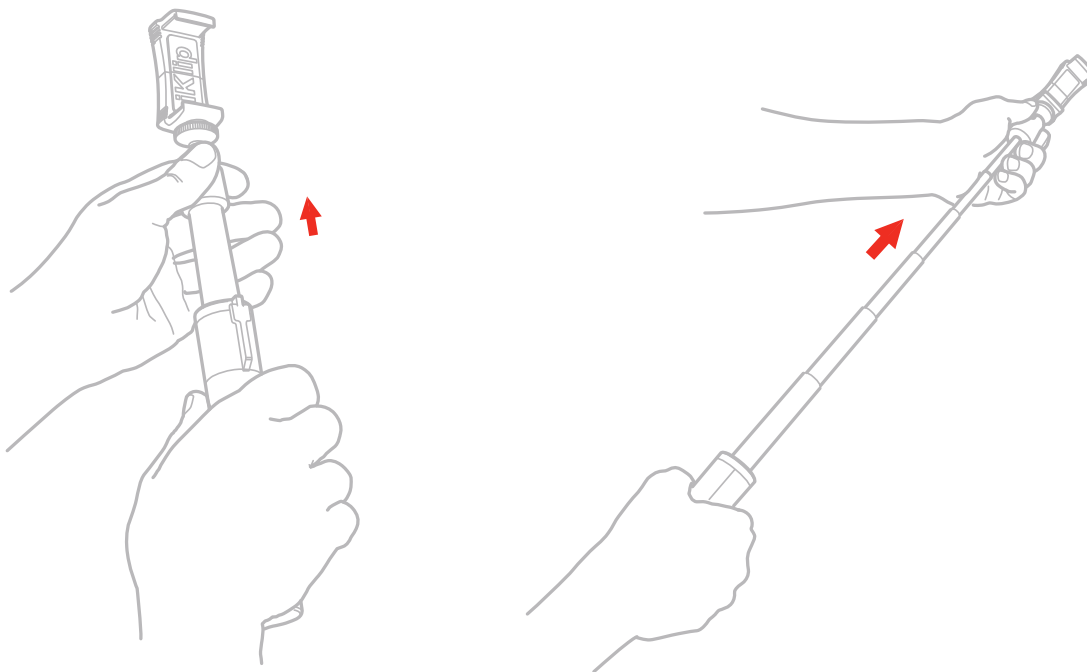

5. Attach the bluetooth shutter to the handle

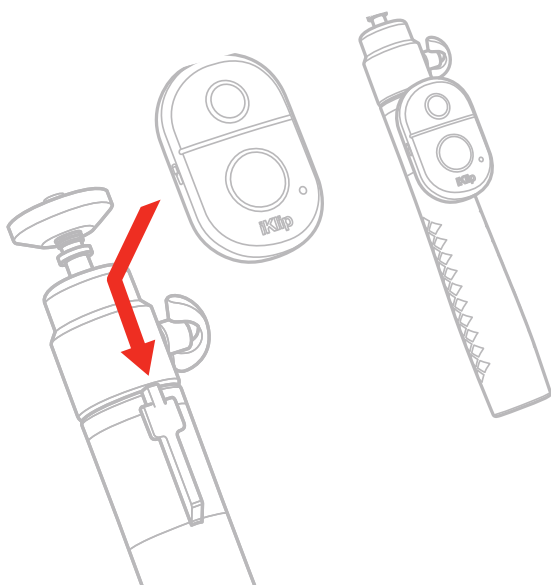

6. Use the lanyard to secure the iKlip GO to your wrist.

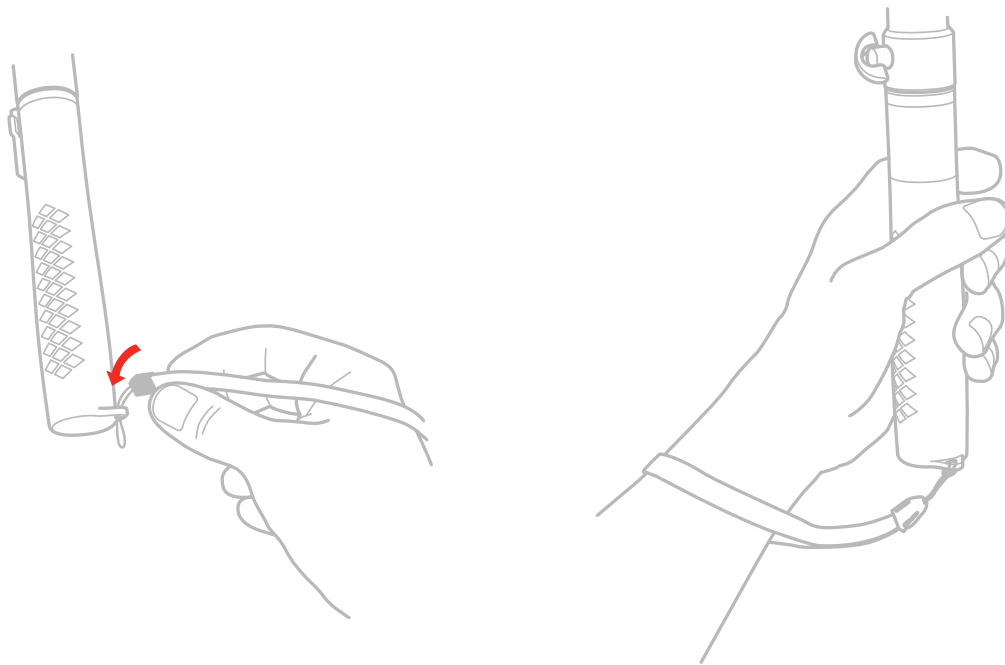

7. Mount the Xpand holder to any camera stand equipped with a standard 1/4"-20 thread.

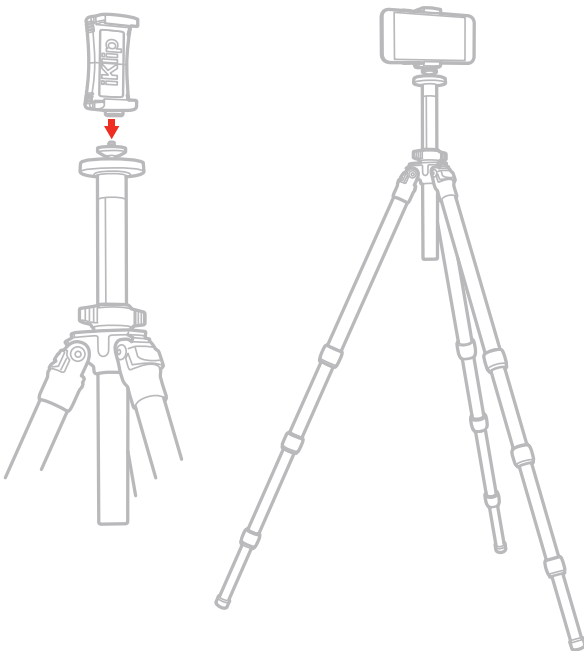

Using the Bluetooth shutter

1. Turn on the shutter by switching the ON/OFF button on the side of the controller. The shutter controller will enter into pairing mode and the LED indicator starts flashing quickly at the same time.

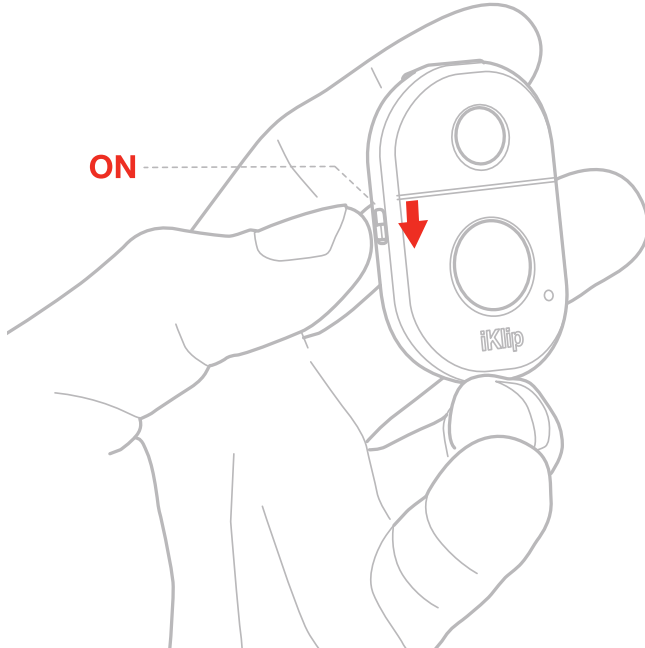

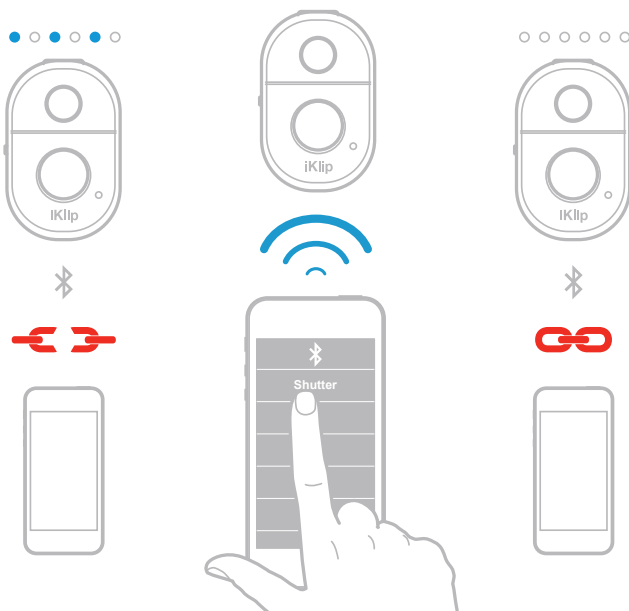

2. Activate the Bluetooth setting on your device and it should “look” for new Bluetooth devices.
3. Select the “Shutter” device from the list and you should be ready to start capturing video and photos using your new shutter controller.

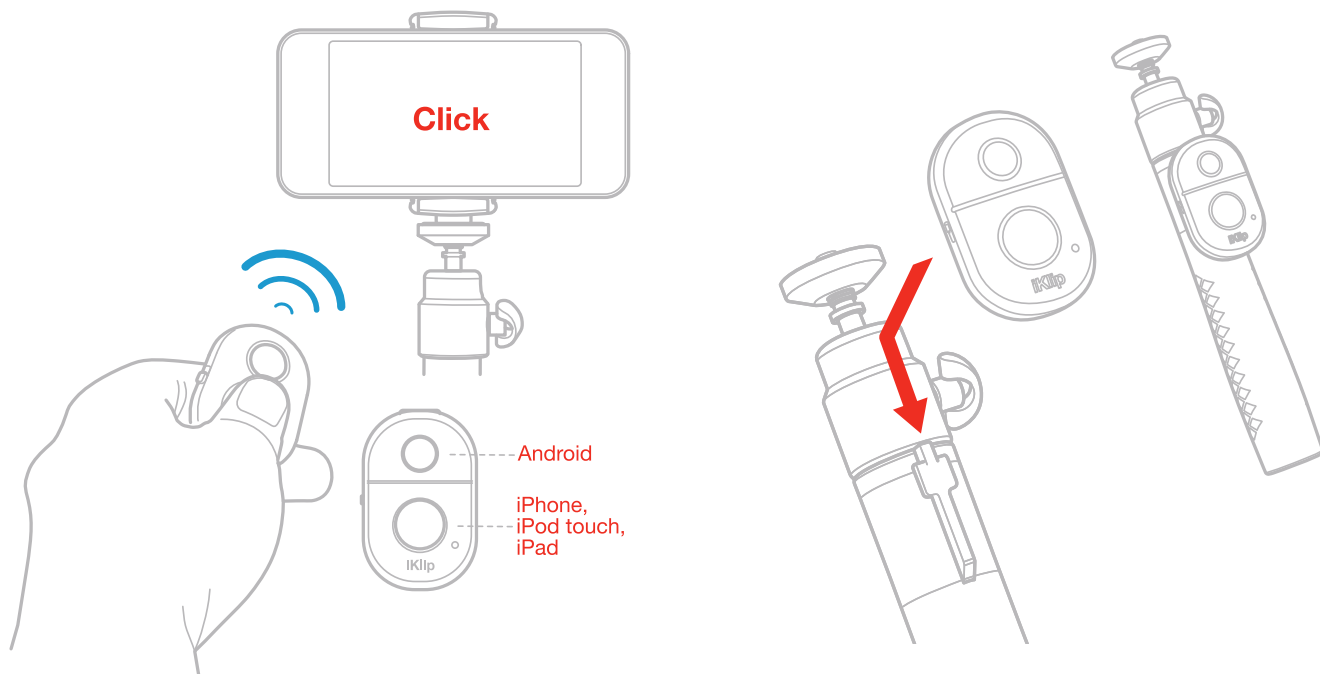

4. You can fix the shutter on the body of iKlip GO thanks to its sledge.

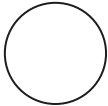
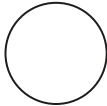

Compatible Devices

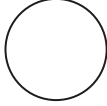
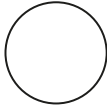
Compatibility list	Built-in camera app	Camera360 app
iPhone 6 Plus/6/5s/5c/5, iPhone 4s/4, iPad 4/3/2, all iPad, iPod touch 4th gen. Or newer		
Samsung Galaxy S2/S3/S4+, Note 1, Note 2, Note 3+, Tab 2, Note 8, 10.1+, Moto X/Nexus 4,5,7+ / Xiaomi 1S,2S,3+		
Sony Xperia S, HTC New One and X+, Other Android phones	NOT COMPATIBLE	

Specifications

Extends up to 74cm / 29.1"

Expandable grip from 2.13"/54mm up to 3.58"/91mm

Ball-joint attachment allows for 90° angle and 360° rotation

Standard UNC 1/4"-20 threaded ball mount

Works with smartphones with screens from 3.5" to 6" with case on

Maximum weight applicable: <1kg

Handle material: TPU

Pole material: Aluminum

Warranty

Please visit:

www.ikmultimedia.com/warranty

for the complete warranty policy.

Support and more info

www.ikmultimedia.com/support

www.iklipgo.com

Regulatory

Model: iKlip Go
 Model Number: IK000095
 Bluetooth Shutter Model Number: 084-104-1-01 (Contains part SFR1002)

U.S.A.

Contains Bluetooth shutter with FCC ID : 2ADMCSF2001



FCC statement

This device complies with Part 15 of the FCC Rules. Operation is subject to the following two conditions:

1. This device may not cause harmful interference.
2. This device must accept any interference received, including interference that may cause undesired operation.

Changes or modifications not expressly approved by the party responsible for compliance could void the user's authority to operate the equipment.

NOTE: This equipment has been tested and found to comply with the limits for a Class B digital device, pursuant to Part 15 of the FCC Rules. These limits are designed to provide reasonable protection against harmful interference in a residential installation.

This equipment generates, uses, and can radiate radio frequency energy and, if not installed and used in accordance with the instructions, may cause harmful interference to radio communications. However, there is no guarantee that interference will not occur in a particular installation. If this equipment does cause harmful interference to radio or television reception, which can be determined by turning the equipment off and on, the user is encouraged to try to correct the interference by one or more of the following measures:

1. Reorient or relocate the receiving antenna.
2. Increase the separation between the equipment and receiver.
3. Connect the equipment into an outlet on a circuit different from that to which the receiver is connected.
4. Consult the dealer or an experienced radio/TV technician for help.

EUROPE



AUSTRALIA/NEW ZEALAND



BRAZIL

Modelo: Remote Shutter



04464-15-05139

Technical Specifications / Especificações técnicas:
 Operation Frequency / Frequência de operação: 2402-2480 MHz
 Bluetooth Version / Versão do Bluetooth: V3.0
 Modulation / Modulação: GFSK

Este equipamento opera em caráter secundário, isto é, não tem direito a proteção contra interferência prejudicial, mesmo de estações do mesmo tipo, e não pode causar interferência a sistemas operando em caráter primário.

UNITED ARAB EMIRATES

TRA
 REGISTERED N°: ER48399/16
 DEALER N°: DA45962/15

TAIWAN



CCA17LP4980T1

FCC radiation exposure statement

This equipment complies with FCC radiation exposure limits set forth for an uncontrolled environment. This equipment should be installed and operated with minimum distance 20cm between the radiator & your body. End users must follow the specific operating instructions for satisfying RF exposure compliance. This transmitter must not be co-located or operating in conjunction with any other antenna or transmitter.

CANADA

Contains/Contient Bluetooth shutter with IC ID: 20638-SFR1002

IC statement/warning

This device complies with Industry Canada licence-exempt RSS standard(s). Operation is subject to the following two conditions:

1. This device may not cause interference, and
2. This device must accept any interference, including interference that may cause undesired operation of the device.

To comply with Industry Canada RF radiation exposure limits for general population, the antenna(s) used for this transmitter must be installed such that a minimum separation distance of 20cm is maintained between the radiator (antenna) and all persons at all times and must not be co-located or operating in conjunction with any other antenna or transmitter

Changes or modifications not expressly approved by the party responsible for compliance could void the user's authority to operate the equipment.

Avertissement IC

Le présent appareil est conforme aux CNR d'Industrie Canada applicables aux appareils radio exempts de licence. L'exploitation est autorisée aux deux conditions suivantes:

1. l'appareil ne doit pas produire de brouillage, et
2. l'utilisateur de l'appareil doit accepter tout brouillage radioélectrique subi, même si le brouillage est susceptible d'en compromettre le fonctionnement.

Pour satisfaire les limites d'exposition aux radiations RF de l'Industrie Canada, les antennes utilisées pour cet émetteur doivent être installées de façon telle qu'au moins 20cm séparent l'émetteur (antenne) de toute personne, et ne doivent être ni situées ni utilisées en conjonction avec n'importe quelle autre antenne ou émetteur.

SINGAPORE

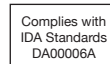

JAPAN



CHINA

CMIIT ID: 2015DP5291

KOREA

	상호 또는 설명	Shenzhen Kinlan Technology Limited
	기자재의 명칭	특정소출력 무선기기(무선데이터통신시스템용무선기기)
	모델명	SFR1002
	인증번호	MSIP-CRM-KIN-SFR1002
	제조연월	2015.10
제조사/제조국가	Shenzhen Kinlan Technology Limited / 중국	
해당 무선설비는 운용 중 전파(전파)혼신 가능성이 있음 *		