

# SAPÈL

TAMED RANDOM SOURCE

1. SAFETY & WARRANTY	2
2. WHAT IS SAPÈL	3
3. CONNECT THE POWER	3
3.1. Warm-up and working temperature	3
4. MOUNTING THE MODULE	3
5. FEATURES	4
5.1. Noise outputs	4
5.2. Clock Generation	4
5.3. Probabilities distribution (aka Stored Random Voltages)	5
5.4. Fluctuating Random Output and Global Rate of Change	5
5.5. Non Quantized Random Sample & Hold	5
5.6. Quantized Random Voltages	5
6. FLOW CHART	7
7. TECHNICAL DETAILS	8
8. QUALITY CONTROLS	8
9. WHAT'S IN THE BOX	8

# 1. SAFETY & WARRANTY

This product is covered by the Frap Tools srls (hereinafter "Frap Tools") warranty, for two (2) years following the date of purchase. This warranty covers any defect in the manufacturing of this product. This warranty does not cover any damage or malfunction caused by incorrect use as described in the following instructions.

The warranty covers replacement or repair, as decided by Frap Tools. Please contact customer service at [hello@frap.tools](mailto:hello@frap.tools) for a return authorization.

Frap Tools warrants that your new Frap Tools product, when purchased at an authorized Frap Tools dealer, shall be free of defects in materials and workmanship for a period of two (2) years from the original date of purchase. Please contact Frap Tools for warranty and service outside of Europe. During the warranty period, Frap Tools shall, at its sole option, either repair or replace any product that proves to be defective upon inspection by Frap Tools. Frap Tools reserves the right to update any unit returned for repair and to change or improve the design of the product at any time without notice. This warranty can be transferred to anyone who may subsequently purchase the product provided that such transfer is made within the applicable warranty period and Frap Tools is provided with all of the following items:

- all warranty registration information for the new owner;
- proof of the transfer within thirty (30) days of the transfer purchase, and a photocopy of the original sales receipt.

Warranty coverage shall be determined by Frap Tools in its sole discretion. This is your sole warranty. Service and repair of Frap Tools products are to be performed only by Frap Tools or an authorized service company. Unauthorized service, repair or modification will void this warranty.

Please follow the given instructions for use of the device because this will guarantee correct device operation. Due to the fact that these instructions also include indications concerning Product Liability, it is absolutely imperative that they be read carefully. Any claim for defect will be rejected if one or more of the following points is not observed. Disregard of the instructions can void the warranty.

The device may only be used for the purpose described in this operating manual. Due to safety reasons, the device must never be used for purposes not described in this manual. If you are not sure about the intended purpose of the device please contact an expert or Frap Tools at the email address above.

Do not use or store the device in humid places. Avoid contact with any kind of liquid.

Do not touch any component of the device when it is power or connected to any power source.

Do not place the device on unstable carts, stands, tripods, tables, or other surfaces, or on surfaces which are not perfectly plane. This may cause the device to fall which could result in human injury, property damage and/or improper functioning of the device itself.

The device is designed for use only when safely and tightly mounted in a proper eurorack case, made of non flammable materials. If you are not sure about the intended purpose of the device please contact an expert or Frap Tools at the email address above.

Do not ever leave the device switched on when not in use.

To prevent fire, never place any type of candle, or fire, or other source of heat on or near the device.

Transport the device only in the original box with original packaging or when safely and tightly mounted in a proper eurorack case, and handled with care. Never let the device fall or topple. Make sure that during transport and while in use the device and its case, have a proper stand and does not fall, slip or turn over because of potential human injury to persons and/or property damage. Any damage from physical abuse such as dropping the unit, impact from hard objects or damage to external components as a result of negligence will void this warranty.

Never subject the device to temperatures above +40°C or below 0°C. Before operation, also verify operating temperature ranges of all the modules and the power boards in use. Do not keep or leave the case that hosts the device, or the device itself near heat sources.

Any modification must be carried out only by Frap Tools or an authorized service company. The device may not be modified in any way by any parties not expressly authorized by Frap Tools. Any repair, modification, tampering, or attempted repair made by unauthorized personnel will void this warranty.

Frap Tools can not be held responsible in any way for problems to persons or property or to the device itself, if the device is installed improperly, or if it is improperly used, maintained, or stored.

Any device shipped to Frap Tools for return, exchange, warranty repair, update, or examination must be sent in its original packaging! Any other deliveries will be rejected. Therefore, you should keep the original packaging, and any technical documentation or manual provided. The device must be shipped only with the original packaging. As specified on the product box, this box is not intended for shipment: if you bought the device directly at a physical reseller's shop, you should put the device in the original packaging and put the packaging in a proper larger box with proper packaging destined for shipping. If you received the device via carrier or any post service, it should have come with a proper double box packaging.

All non-warranty services are subject to a minimum fee of €50.00+VAT (within the European Union). The customer must pay for shipping to Frap Tools, Frap Tools will cover return shipping costs.

It is important to note that the front panel of the SAPÈL module may get warm, and may warm up the case where it is mounted. Please do not be alarmed, as this is normal and is part of its standard operation.

Shut down your equipment immediately if it produces smoke, a strange odor, or unusual noise. Continued use may lead to fire. Immediately unplug the equipment and contact your dealer or Frap Tools at the address above for advice.

Never attempt to repair this product yourself. Improper repair work can be dangerous. Never disassemble or modify this product. Tampering with this product may result in injury or fire and will void your warranty.

Do not allow foreign matter to fall into the equipment. Penetration by foreign objects may lead to fire.

If water or other liquid spills into this equipment, do not continue to use it. Continued use may lead to fire. Unplug the power cord immediately and contact your dealer or Frap Tools at the address above for advice.

**WARNING:** The internal components of the SAPÈL module can get very hot. Do not touch the internal components while it is connected and/or powered and after they completely cool down after use for at least 30 minutes.

## 2. WHAT IS SAPÈL

The SAPÈL is a random control voltages source for eurorack modular systems. It is composed of two main sections, one that generates audio noises in 4 different versions, and another which includes two selectable random clock, random voltages and clock sources.

Noise outputs are color coded, based on the noise colors, and include blue (+3dB/oct spectrum), white noise (0dB/oct spectrum), pink noise (-3dB/oct spectrum), red noise, a.k.a. brown or brownian (-6dB/oct spectrum).

Each of the two random sources section features four full analog and totally independent random CV generation paths, divided in;

- fluctuating random voltage;
- quantized random voltage with  $2^n$  stages tuned in semitones referred to 1V/oct scale;
- quantized random voltage with  $n+1$  stages tuned in octaves referred to 1V/oct scale;
- non quantized sample & hold.

It is also possible to set a probability distribution, with a potentiometer, and apply (or do not apply) the chosen distribution setting to each of the four paths independently.

Furthermore, each of the two random sources section features a built-in clock generation, with output for clock and random clock. This can be used in “more than / additive” mode or “less than / subtractive” mode. It is possible to use an external clock signal as a clock source, bypassing the built-in clock generator. In addition, it is also possible to hand trigger the clock via a manual sample & hold button, which can be modulated by gate signals too.

100% analog noise and random generation: we know this is against the current tendency of modules design, but if well designed, we believe this lead the user to obtain a truly random control generation.

The only “digitalized” areas, if we can call them in this way, are the quantizers of the quantized random voltages.

## 3. CONNECT THE POWER

Before to connect the power cable, pay attention to:

- the power connector on the module is the keyed one in the top;
- the power supply you are using is able to power up properly the module and the rest of the other modules connected to that power supply. We strongly suggest to keep a 25% of margin on the available power of your power supply.
- the red line on the cable should be placed matching the -12V side on your power board: please double check with your power board supplier that the marked side is the -12V:

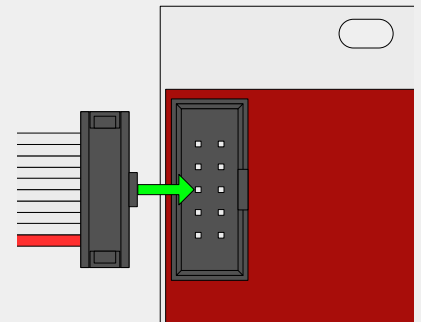

**WARNING:** Frap Tools can not be held responsible in any way for problems or damage to persons or property or to other equipment or to the device itself, if the device is not connected as indicated above and following the precautions we noted above.

### 3.1. Warm-up and working temperature

For best performances, we suggest to let the SAPÈL warm up around 15 minutes prior to use it [tested at 25°C]. It is absolutely normal that it feels warm when using it!

## 4. MOUNTING THE MODULE

After connecting the power as explained in the previous section, install the 18HP module in your case using the 4 screws provided you prefer, being sure the module is safely and tightly connected to your eurorack case.

The SAPÈL module use the standard eurorack orientation, red line is -12V. Please double check with the power system you want to use that both uses the same powering system.

**WARNING:** Frap Tools can not be held responsible in any way for problems or damage to persons or property or to other equipment or to the device itself, if the device is not connected as indicated above and following the precautions we noted above.

## 5. FEATURES

We'll explain only the noise section and the yellow section, since the green section is exactly the same but specular to the yellow one.

### 5.1. Noise outputs

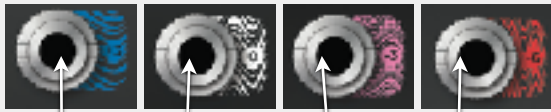

1. Blue noise (+3dB/oct spectrum)
2. White noise (0dB/oct spectrum)
2. Pink noise (-3dB/oct spectrum)
3. Red noise, also known and brown or brownian (-6dB/oct spectrum).

### 5.2. Clock Generation

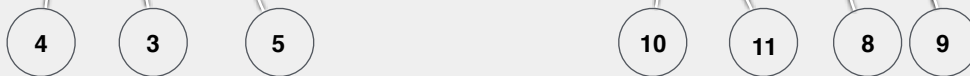

The clock section generates a precise clock signal and two random clocks. It accepts an external clock connection to bypass the built-in one. The clock signal is used to trigger the sample&hold circuits used in the quantized and non quantized random voltages, and is sent to the clock output and to the random clock output.

1. Clock Frequency
2. External Clock Input. Any patched signal replaces the built-in clock.
3. Manual Sample&Hold button. It samples each time the button is pressed and holds until the button is left.
4. LED for manual Sample&Hold button: it is lighted when the manual button or the external gate are "in hold".
5. Gate/CV input for modulation. When the Gate/CV target switch (6) is on the left a Gate signal can be used to automate the Manual Sample&Hold. When the Gate/CV target switch (6) is on the right a CV can be used to modulate the Clock Generator Frequency.
6. Gate/CV target switch: see point (5) for details.
7. Single/Both clock sources for Sample&Hold. When the switch is on the side of the colored square both clocks from yellow and green Clock Generator are used together in the three Sample&Hold circuits. When the switch is not on the side of the colored square, only the Clock Generator of the circuit is used.
8. Clock output
9. LED for Clock output
10. Random Clock Output, depending on the switch (12) position. If up, or in "more than" mode, it outputs all clock impulses generated from the clock in addition to other random clocks, which time density depends on the "global rate of Change" pot of the fluctuating random section. If down, or in "less than" mode, it outputs the Clock generated from the Clock only "sometimes", even there based on a random circuit.
11. LED for Random Clock Output
12. Switch for Random Clock Output: see details at point (10)

### 5.3. Probabilities distribution (aka Stored Random Voltages)

It is possible to define a global probabilities distribution of the magnitude of the four random signals. For each section, with a switch this distribution can be activate or not.

1. Probabilities distribution potentiometer: set it fully counterclockwise and most of the random signals have a low magnitude, while at the same time, even medium and high magnitude voltages may appear, only with a with smaller probability. As the potentiometer is turned clockwise the distribution moves through medium to high magnitude voltage probability. The symbol with yellow/green background between the two small potentiometers shows an idea of these possible distributions.
2. Enable probabilities distribution for the Sample&Hold random voltage.
3. Enable probabilities distribution for the fluctuating random voltage.
4. Enable probabilities distribution for the n+1 Quantized random voltage.
5. Enable probabilities distribution for the 2<sup>n</sup> Quantized random voltage.



### 5.4. Fluctuating Random Output and Global Rate of Change



This section generates a fluctuating random voltage with a range varying from 0 to 7.5V. As described above this signal can be linked to the main probabilities distribution.

1. Rate of change: as much as the pot is rotated clockwise, as much as the random voltages change rapidly.
2. CV in for Rate of Change
3. Fluctuating Random Output
4. LED for Fluctuating Random Output

Please note that this section influences the behavior of the random clock in both modes.

### 5.5. Non Quantized Random Sample & Hold

SAPÈL contains three sample & hold circuits for each of the two main section (green and yellow): one of these three is coupled with an independent random generator and creates non quantized stepped voltages with a range varying from 0 to 7.5V. As described above this signal can be linked to the main probabilities distribution.



1. CV Signal Output.
2. LED of outgoing CV.

### 5.6. Quantized Random Voltages

Each of these two sections generates quantized random voltages, but with a slightly different approach, as proposed in the historical Buchla module Source of Uncertainty Model 266. The principle is similar, but the circuit has been designed from scratches using another approach in order to obtain a more “random” voltages distribution and an extremely precise voltages quantization, capable of generating precise semitones or octaves.

Furthermore, all controls are independent, with exclusive pot and CV modulation to define the number of quantization stages for the n+1 and 2<sup>n</sup>.

As in the original 266 module, the “n” parameter, which defines the number of stages, goes from 1 to 6.

As described above these signals can be linked to the main probabilities distribution.

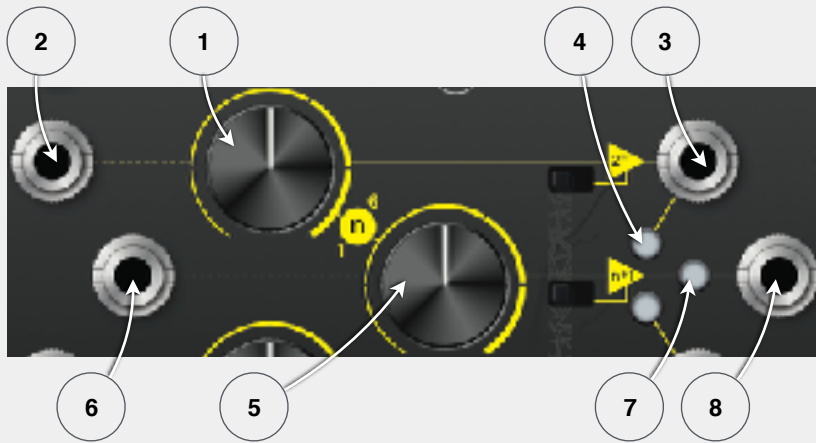

1. "n" Number of stages (from 1 to 6) for the  $2^n$  quantized random voltage (quantized to  $1/12V$  steps, or semitones in the  $1V/oct$  scale, with "n" value going from 1 to 6, so from 2 to 64 stages, or from 0V to 5.25V).
2. "n" CV modulation in.
3.  $2^n$  quantized random voltage signal output.
4. LED of outgoing CV.
5. "n" Number of stages (from 1 to 6) for the  $n+1$  quantized random voltage (quantized to  $1V$  steps, or octaves in the  $1V/oct$  scale, with "n" value going from 1 to 6, so from 2 to 7 stages, or from 0V to 6V).
6. "n" CV modulation in.
7.  $2^n$  quantized random voltage signal output.
8. LED of outgoing CV.

The following charts show the exponential and linear distribution of number of stages for semitones/ $2^n$  and for octaves/ $n+1$ , when increasing the "n" value from 1 to 6.

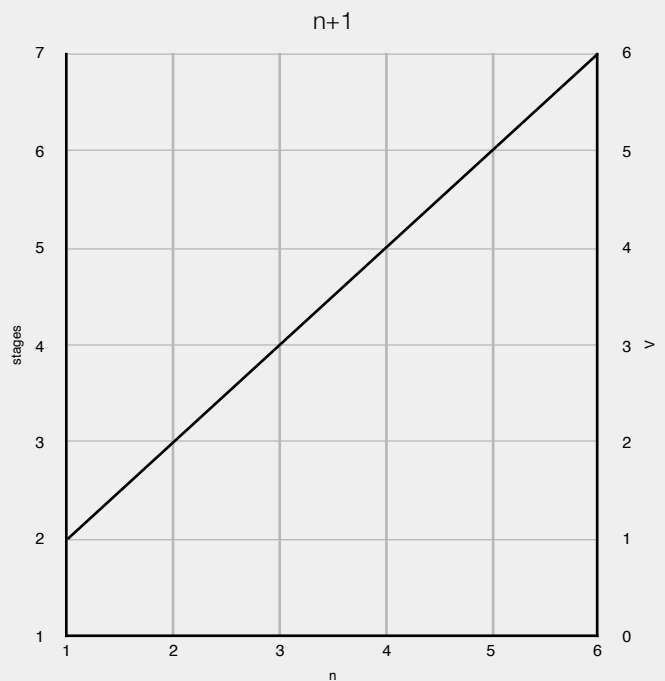
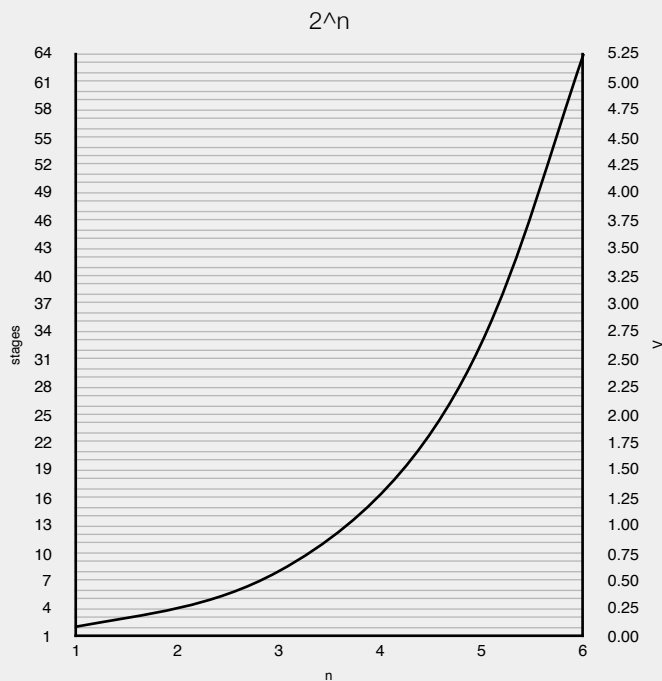

# 6. FLOW CHART

Flow chart of one of the two specular sections

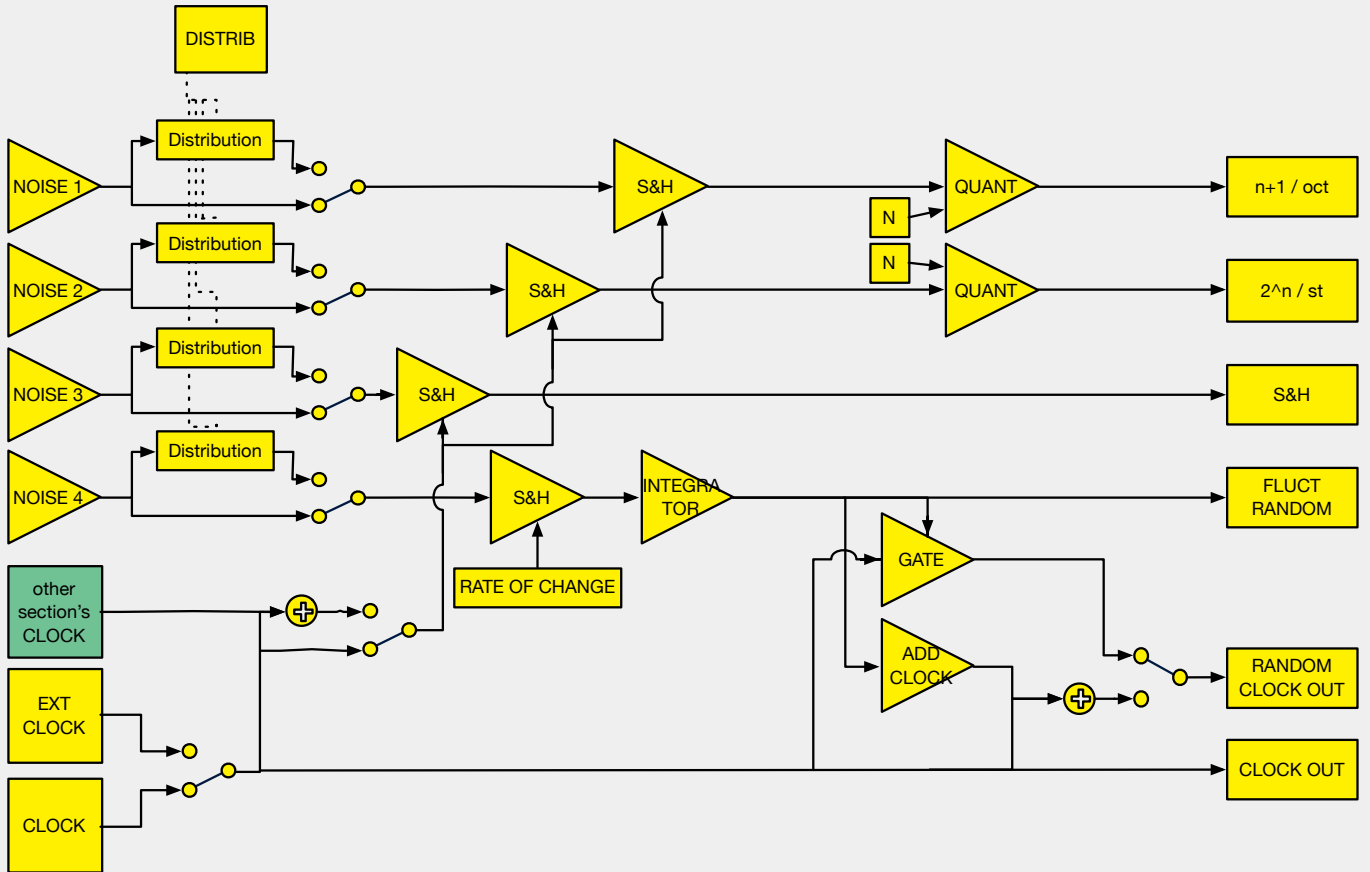



## 7. TECHNICAL DETAILS

SAPÈL size is 18HP.

CV input impedance 100 K $\Omega$   $\pm$ 10%.

Clock input impedance ~100 K $\Omega$  on positive pulses, ~30 K $\Omega$  clamping negative pulses.

Built in clock frequency range goes from around 0.1Hz to around 60Hz. It can reach lower frequencies (longer times) if a negative CV is used as modulation.

Tolerance of quantized random voltages < 1%, with global offset within  $\pm$ 10 mV (or  $\pm$ 12% of semitone).

Clock output: period of ~2ms, amplitude of ~9V.

Sampling glitch on sample & hold output < 400 $\mu$ s.

Sampling glitch on quantized outputs not appreciable.

Colored Noise Output (tolerance of  $\pm$ 2dB).

- blue noise amplitude +10dBu RMS
- white noise amplitude +10dBu RMS
- pink noise amplitude +7dBu RMS
- red noise amplitude +4dBu RMS

Current Draw

idle	+12V	250 mA
	-12V	170 mA

## 8. QUALITY CONTROLS

100% of SAPÈL modules are tested in the following aspects:

- correct behavior, power consumption and avoid any failed components with a 1 hour burn-in
- CV inputs curves after minimum 20 minutes of warm up
- quantized voltages tolerance
- clock frequencies
- correct LEDs behavior
- pots, buttons switches, jack sockets and any mechanical part stress test
- visual quality inspection

100% of SAPÈL cable is testes in the following aspects:

- mechanical behavior
- shorts
- open pins

## 9. WHAT'S IN THE BOX

code	description	composed by	Q.ty
		SAPÈL Module	1
F-SAP0-RG	SAPÈL	16 to 10 poles IDC Power Cable	1
		M3x6 black and Zinc with plastic washer for mounting	4