

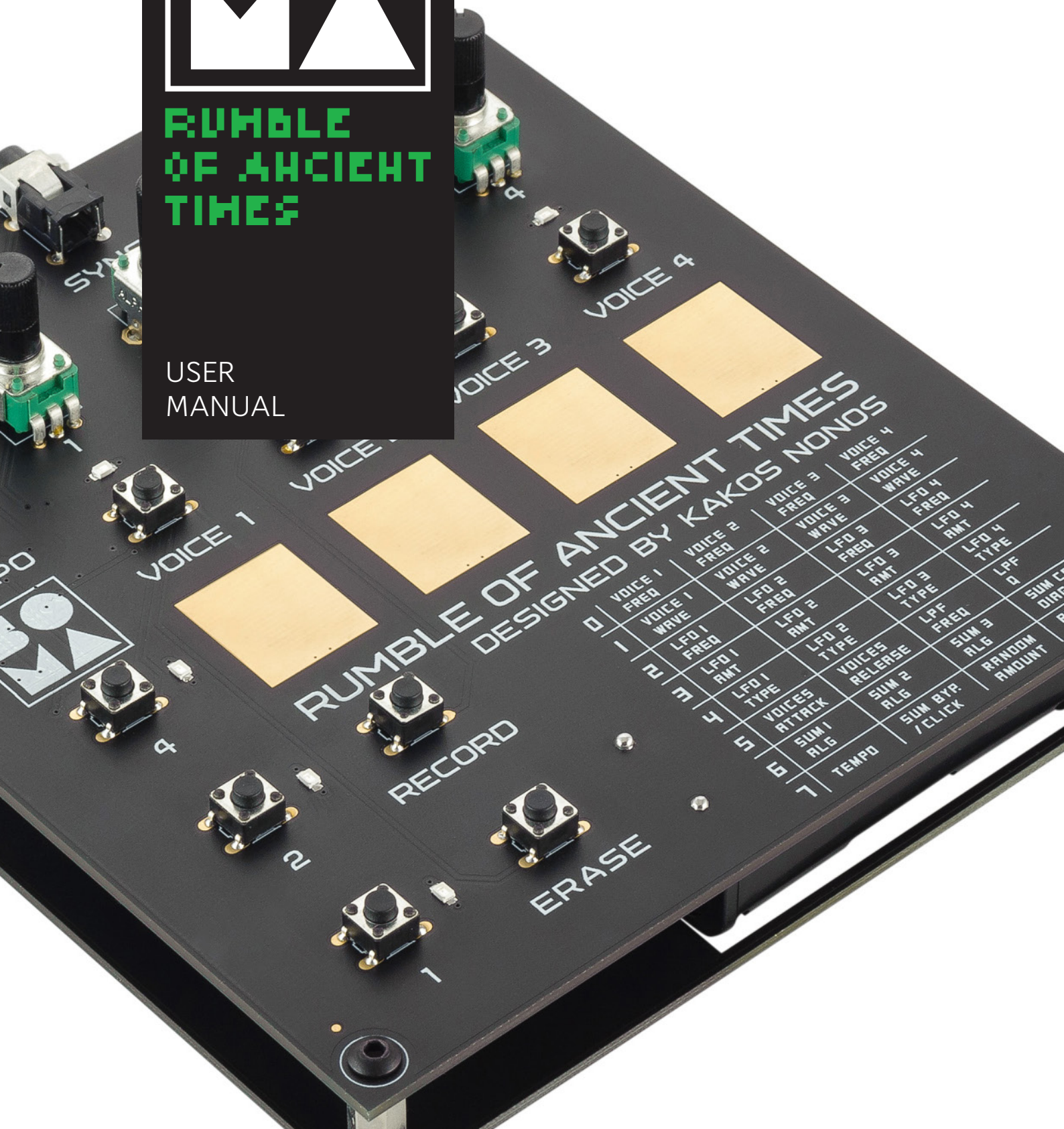

RUMBLE OF ANCIENT TIMES

USER
MANUAL



GENERAL DESCRIPTION

Rumble of Ancient Times (RoAT) is an 8-bit noise synthesizer and sequencer, capable of a wide variety of sounds ranging from dense noise scapes to diverse glitching rhythmic patterns. The compact and portable instrument has many features that can be combined into surprising musical results.

SOUND SYNTHESIS DESCRIPTION

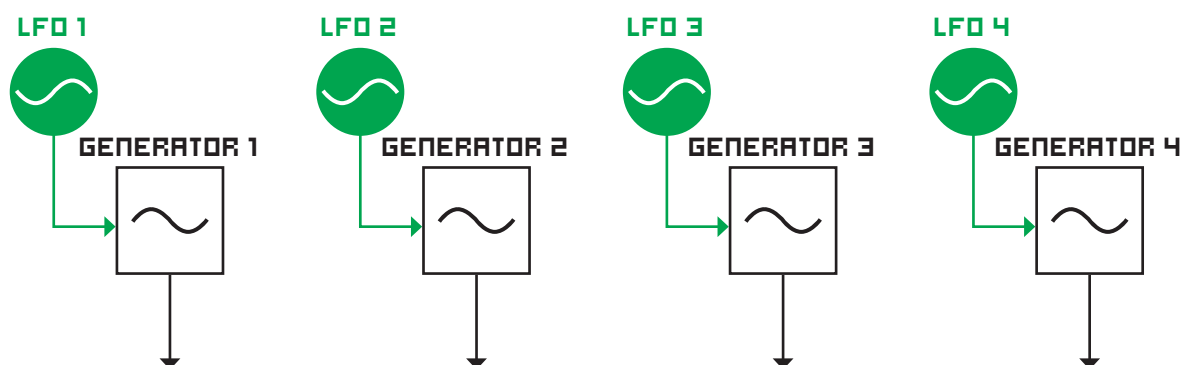

The "heart" of the synthesizer contains 4 sound oscillators, each with a tunable waveform and an LFO, which can modulate the tone or volume of the oscillator. The modulated signal of each oscillator is mixed with other signals in one of three ways:

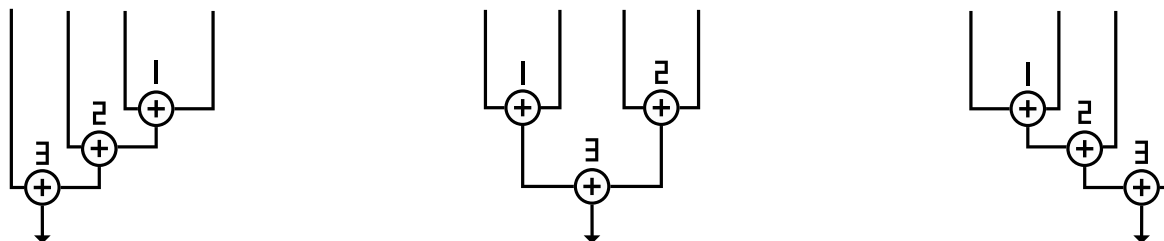

Each mixing method has three nodes where two signals are summed into one. Each mixing node can have a different summing algorithm. Next, the signal goes to the filter with resonance, and then to the audio output.



SOUND OSCILLATORS CAN BE SWITCHED ON AND OFF IN REAL-TIME USING THE INTERFACE OR SEQUENCER.

The buttons switch the channel state between ON and OFF, while the sensors and sequencer invert it. When the channel is off, touching the sensor will turn it on, and when it is on, the sensor will turn it off. The current state of the oscillators is displayed on the LEDs.

To configure the synthesizer, you need to change the values of the registers.



EACH REGISTER CONTROLS A CERTAIN PROPERTY OF THE SYNTHESIZER, AND A TOTAL OF 32 REGISTERS ARE AVAILABLE. IN ORDER TO KEEP THE INSTRUMENT COMPACT AND AFFORDABLE, WE DECIDED TO DIVIDE THE SETTINGS INTO PAGES. THIS SIGNIFICANTLY REDUCED THE NUMBER OF POTENTIOMETERS AND THE SIZE OF THE SYNTHESIZER.

At any given time, you have access to one page with 4 registers, which can be changed with the pots. To access the other parameters, you need to change the page by pressing the page buttons. After changing the page you can configure the parameters available on that page. There are 8 pages in total. Their number is set in binary code (three bits). The current page is displayed on the LEDs; pressing the buttons will invert the bit values. The upper button relates to the highest bit, the lower button to the lowest bit. When the page is changed, the register values do not change. To set a new value, start turning the appropriate pot. Let's look at the registers and the controlled parameters.

The registers are located according to the following table:

PAGE	POT 1	POT 2	POT 3	POT 4
0	CHANNEL 1 FREQUENCY	- 2	- 3	- 4
1	CHANNEL 1 WAVEFORM	- 2	- 3	- 4
2	LFO 1 FREQUENCY	- 2	- 3	- 4
3	LFO 1 AMPLITUDE	- 2	- 3	- 4
4	LFO 1 TYPE	- 2	- 3	- 4
5	ATTACK	RELEASE	FILTER CUT	FILTER RESONANCE
6	SUMMATION TYPE IN NODE 1	- 2	- 3	SUMMATION DIAGRAM
7	TEMPO	METRONOME AND SUM. BYPASS	RANDOM 1 (AMOUNT)	RANDOM 2 (SPEED)

According to this table, if you need to change, for example, the amplitude of the LFO of channel 2, you need to go to page 3 (011) and start turning the second potentiometer.

Next, let's take a closer look at all the registers.

SOUND OSCILLATORS

Pages 0 and 1 are for tuning the sound oscillators. Pots on page 0 will change the tones of the sound oscillators from 19 to 1,350 Herz. Page 1 will change the waveform of the oscillator. There are 16 waveforms available:

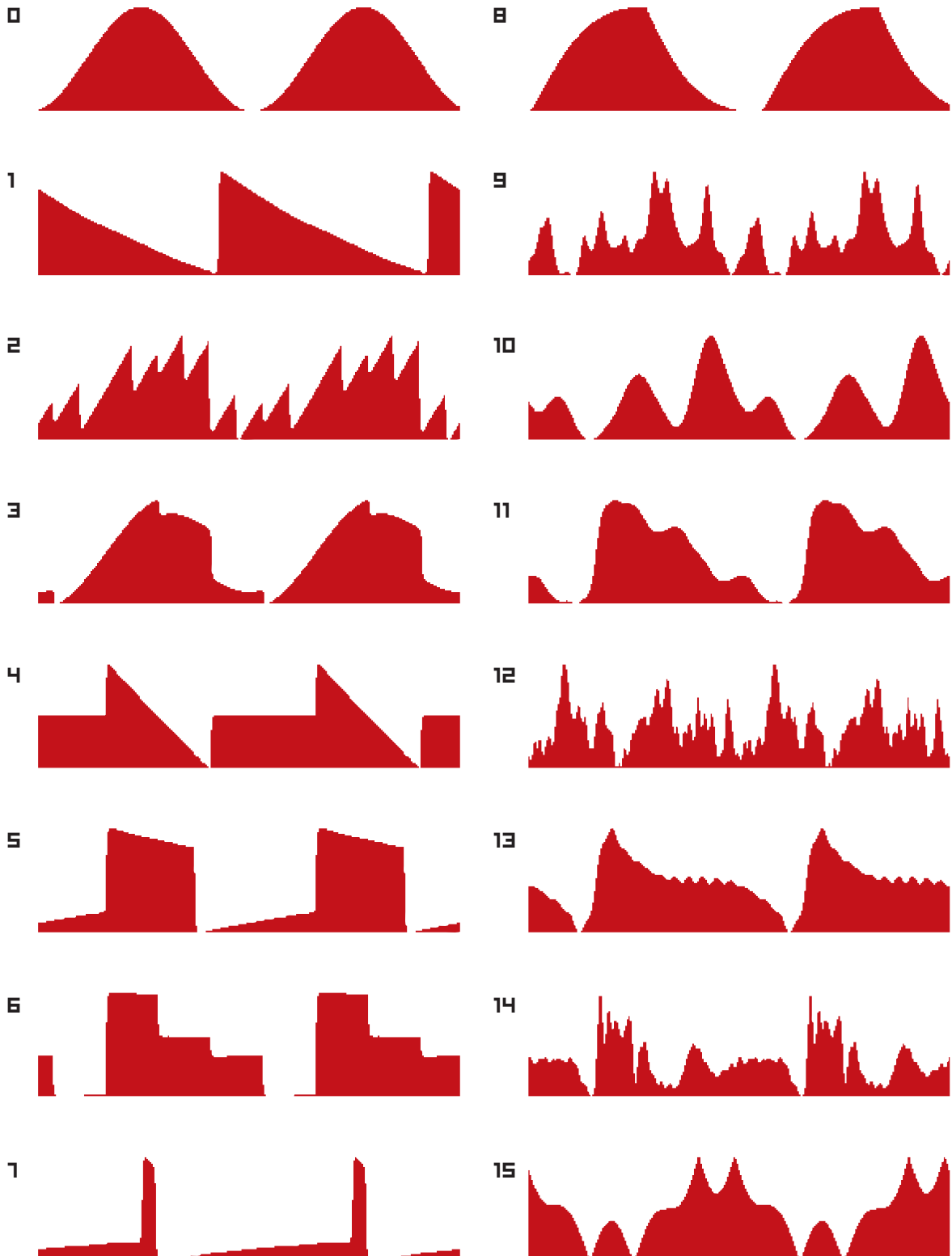

LOW-FREQUENCY OSCILLATORS

LFOs in RoAT are used to control the main oscillators of the synthesizer.

THEY CAN MODULATE EITHER THE TONE OF THE OSCILLATOR OR ITS VOLUME. THEY ARE CONTROLLED ON PAGES 2,3 AND 4.



Registers on page 2 control the frequency of the LFO. Each potentiometer on this page controls one LFO, corresponding to the sound oscillator.



THE LFO HAS TWO DIFFERENT MODES. THE FIRST MODE ALLOWS SETTING THE FREQUENCY WITH PRECISION BY TURNING THE POTENTIOMETER. IN THE SECOND MODE, TURNING THE POTENTIOMETER WILL SET THE MULTIPLIER OF THE INTERNAL TEMPO.

Meanwhile, the values of all pots will be connected. Let's say, the clock is set to 2 Hz. By using the multipliers, it is possible to get LFO frequencies of 2, 4, 8, 16 Hz. As a result, the LFOs are connected and it is possible to get interesting rhythmic effects. The mode settings and tempo are controlled on page 7.

Page 3 controls the impact of the LFO. It's simple: if a potentiometer is at zero, its oscillator will not affect the sound. The higher the potentiometer, the higher the impact of the LFO.

The potentiometers on the 4th page are for the type and waveform of the modulation. Here is how it is organized: each potentiometer can receive 16 values. The first 8 values are for modulating the tone of the sound oscillator, the other 8 for its volume. The modulation waveforms will repeat. For example, when value 0 is selected, a sine wave modulates the tone. When value 8 is selected, the same waveform will modulate the volume. Available waveforms are shown in the table below:

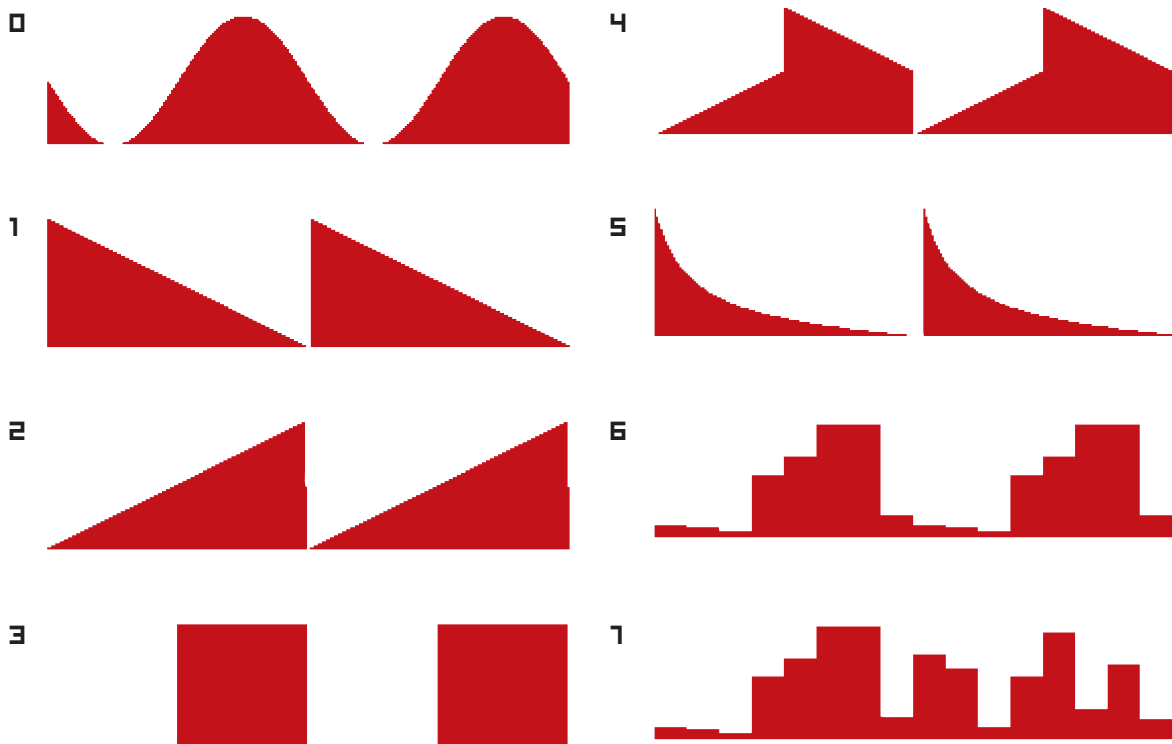

Let's talk more about the last two waveforms. Waveform 7 is a random values generator.

IF YOU SWITCH TO WAVEFORM 6, ROAT WILL REMEMBER THE LAST 8 VALUES AND LOOP THEM.



If you switch back to 7 and 6 again, the looped values will refresh. The same applies to values 14 and 15.

ENVELOPE AND FILTER

The 5th page contains parameters of the envelope generator and filter settings. The envelope generator turns on when you touch the sensors or when the sequencer is playing. There are two parameters available – attack and release. More details are available in the section 'Channel settings'.

The filter also has two parameters – cutoff and resonance. The filter is applied after all mixing algorithms, described in the next section.

ALGORITHMS FOR MIXING CHANNELS

Page 6 contains the most important parameters with a high impact on the resulting sound. The pots on this page control how and in what order the oscillator signals are mixed to get the final sound.



WE HAVE 4 SOUND CHANNELS, EACH MODULATED BY LFO, THAT WE NEED TO MIX INTO ONE.

To do this, we have 3 connection algorithms available. To select the algorithm, use the 4th pot on this page.

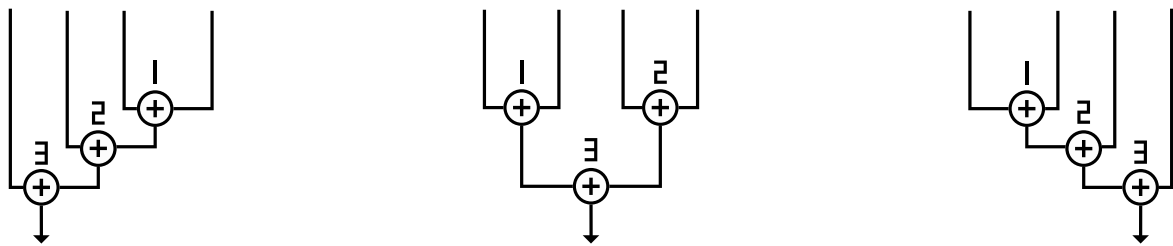

EACH ALGORITHM HAS 3 INTERSECTIONS WHERE THE SIGNALS ARE MIXED. EACH CAN BE INDIVIDUALLY SET TO USE ONE OF 8 ALGORITHMS, DESCRIBED BELOW.



Nodes 1, 2 and 3 are controlled by the corresponding pots on this page.

The available mixing algorithms are the following:

0	ADDITION. SIMPLY ADDING TOGETHER TWO SIGNALS.
1	ADDITION WITH OVERFLOW. IF THE SUM OF THE SIGNALS CROSSES THE UPPER OR LOWER BORDER, THE RESULT IS DIRECTED TO THE OPPOSITE EDGE AND CONTINUES GROWING FROM THERE.
2	SUBTRACTION 1. THE SECOND SIGNAL IS SUBTRACTED FROM THE FIRST. IF THE FIRST SIGNAL IS LOWER, THE RESULT WILL BE ZERO.
3	SUBTRACTION 2. THE LOWER SIGNAL IS SUBTRACTED FROM THE HIGHER SIGNAL.
4	MULTIPLICATION. BOTH SIGNALS ARE MULTIPLIED. THIS EFFECT IS ALSO CALLED RING MODULATION.
5	EXCLUSIVE OR (XOR). IN THIS MODE, A BITWISE XOR IS PERFORMED BETWEEN THE SIGNALS. THE VALUES OF EACH SIGNAL ARE 8-BIT.
6	FREQUENCY MODULATION (FM). THE FIRST SIGNAL IS MODULATED BY THE SECOND.
7	WAVEFORM MODULATION. FIRST, THE TWO SIGNALS ARE ADDED USING THE FIRST ALGORITHM, THEN THE RESULTING SIGNAL IS WAVE-SHAPED. EACH NODE HAS ITS WAVEFORM ALGORITHM.

The picture shows the results of summing two sine waves using different methods.

SIGNAL 1



SIGNAL 2



+

ADDITION



MULTIPLICATION



ADDITION WITH OVERFLOW



EXCLUSIVE OR (XOR)



SUBTRACTION 1



FREQUENCY MODULATION (FM)



SUBTRACTION 2



WAVEFORM MODULATION



AS A CONSEQUENCE, THERE ARE $8 \times 8 \times 8 \times 3 = 1,536$ POSSIBLE CONNECTION PATTERNS FOR THE SOUND OSCILLATORS.

GENERAL SETTINGS PAGE

The last page contains the general settings of the synthesizer and a generator of random changes, or randomizer. The first potentiometer controls the tempo. In RoAT, tempo affects the speed of the LFO and sequencer. The values on the potentiometer are positioned in the following manner:



When the minimum value is set, the internal clock is turned off. LFOs are not in sync and the sequencer is not active. With the values in the middle, the tempo sync is enabled and depends on the potentiometer position. The clock is displayed on the LED and is sent to the sync-out. The synthesizer functions as master clock and can be the source of tempo for other devices. When the potentiometer value is maximum, the synthesizer tempo starts working in slave mode. The sync-out becomes sync-in and expects an external clock signal. The tempo is synced to the external signal.

AS A RESULT, ROAT CAN WORK IN BOTH MASTER AND SLAVE MODES AND CAN BE A PART OF A SETUP WITH SEVERAL DIFFERENT DEVICES.



The second pot controls the metronome click and bypass settings. Here is how it works:

The click plays when the potentiometer is turned all the way up or down. In all other positions, the metronome is off.

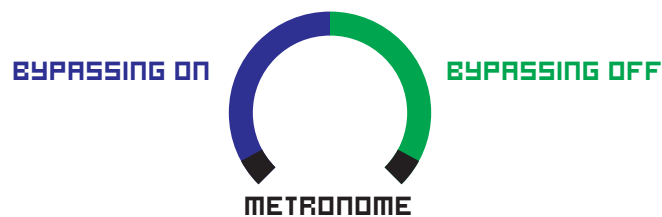

WHEN THE POTENTIOMETER IS IN THE POSITION BEFORE 12 O'CLOCK, THE SYNTHESIZER IS IN BYPASS MODE. IF IT'S PAST 12, BYPASS MODE IS OFF.

The reason to use this mode is described in the chapter "Channel Settings". The randomizer is described in the next chapter.

RANDOMIZER

There are two systems for introducing random changes to the settings in RoAT. The first system is activated when you press the "Chaos" button.

DOING SO WILL RANDOMLY CHANGE ALL PARAMETERS, EXCEPT ATTACK, RELEASE, SYSTEM SETTINGS ON THE LAST PAGE, AND THE SETTINGS ON THE PAGE CURRENTLY SELECTED.



This gives the ability to create interesting effects. For example, you can open page 0 (where oscillator frequency is controlled) and set low values for very low-frequency sounds. Pressing the "Chaos" button at the same time will generate a different sound – still low frequency, but different due to changes in other parameters. The same can be done with the amplitude LFO. Turn it up to maximum to get different rhythmic noises and sounds.

The second randomization system is responsible for gradually changing registers over time. With this system, the registers will gradually change their values over time. This process is controlled by the 3rd and 4th potentiometer on page 7. The 3rd pot sets the number of registers that will take part. When 0 is set, nothing will change. When you turn the pot a little, only the first 4 registers will be affected (the setup is done with steps of 4), and only the oscillator frequency will be changed. If you turn it a little more, the waveform will also be affected, and so on. The 4th potentiometer is responsible for the speed of changes to the registers.



THE CHANGE IS GRADUAL: IT SMOOTHLY GOES UP OR DOWN AND CAN RANDOMLY CHANGE THE DIRECTION.

It also changes direction when it reaches the high or low end. This chart shows an example of a register value changed by the randomizer.

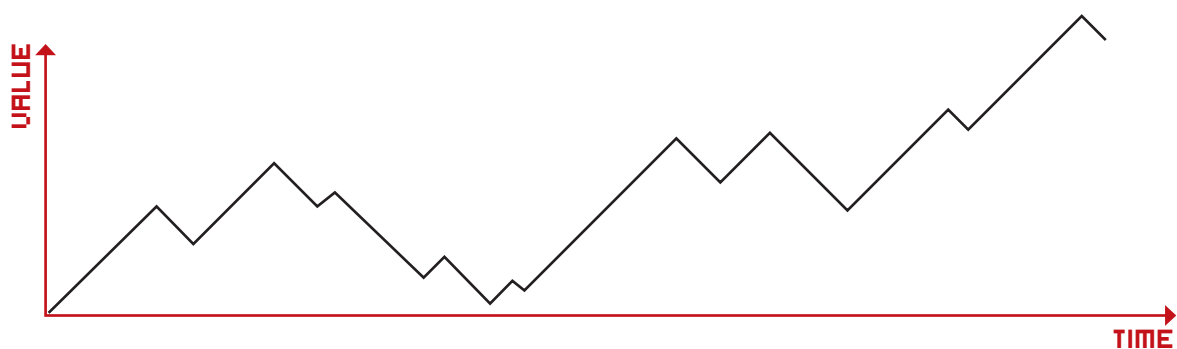

While the randomizer is active, all the potentiometers remain functional. You can scroll through pages and change the values manually, use the sequencer, and so on, adding diversity to the sound. The changes affect all registers, apart from attack, release, and settings on the last page.

CHANNEL SETTINGS

Rumble of Ancient Times has 4 channels, but we can switch some of them off to get a desired sound. You can do this in two different ways:

- ✳ Using trigger buttons— Pressing the button will change the state of the channel: if it was OFF, it will switch it ON and vice versa. The LED shows the current state of the channel.
- ✳ Using sensor buttons— Touching the sensor will invert the current state of the channel. If the channel is ON, touching the sensor will turn it OFF. And if the channel is OFF, touching the sensor lets you tap out morse code :-)
- ✳ The channels can also be controlled by the sequencer. Its work simulates touching the sensors .

The synthesizer has an envelope generator for smoothly switching the channels on and off. This generator has two parameters - attack and release. They are controlled by the 1st and 2nd pots on page 5.



BY USING THE TOUCH PANEL AND ENVELOPE GENERATOR, YOU CAN MOVE AWAY FROM THE MONOTONOUS SOUND AND PLAY IT IN REAL-TIME.

Switching channels off can be done in two different ways. The mode is selected by the 2nd potentiometer on page 7: if before 12 o'clock, the first mode is used; if it's after 12 o'clock — the second mode.

Let's look at the first mode. In the first mode, when the channel has no sound, it is fully excluded from the summing circuit, and the signals from other channels bypass it completely. Here is an example: we turn off the second channel and as a result, the summing operator, connected to this channel, is removed from the circuit and other channels are mixed as if it was not there.

The same happens with other channels. And when only one channel is working, its signal will go to the output without any modulation.

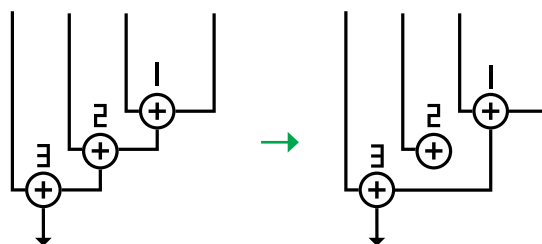

In the second mode, the summing node is not removed, but a null is sent to it instead.

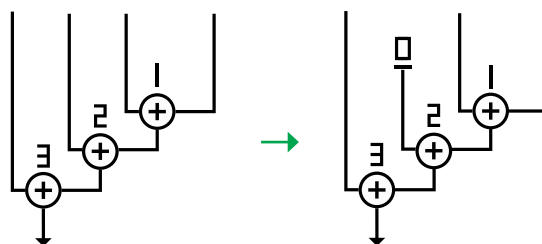



EACH MODE HAS ITS NUANCES AND RANGE OF USE.

The first mode, bypassing the summing nodes, can be used to make sure the signal continues when one of the channels is switched off. Let's look at an example. Here, the lowest mixing node uses frequency modulation (the left signal is modulated by the right signal) and if we turn down the first channel to zero, we will be modulating a constant, and that means silence. By switching off one channel, we stop the whole system and cannot tune the other three channels. For this case, we can turn off the summing circuit.

However, this system has its nuances when using it with an envelope generator. Normally, the envelope smoothly lifts up and lowers down the volume of the oscillator, but when the "bypass" mode is on, it is impossible to achieve smoothness. The summing algorithm changes before the attack and after the release. As a result, in certain configurations, especially while playing on touch sensors, you can get unusual effects when the sound will abruptly change after release. For example, this effect is possible with the previously mentioned FM modulation on the ending circuit. Before touching the sensor we hear a loud sound, and after touching, it goes silent and rises with the speed of attack before reaching maximum level. Next, after releasing the sensor the sound level falls until it reaches silence and then a loud sound abruptly starts from the three channels (with one channel turned off). The image shows the reason for this effect.

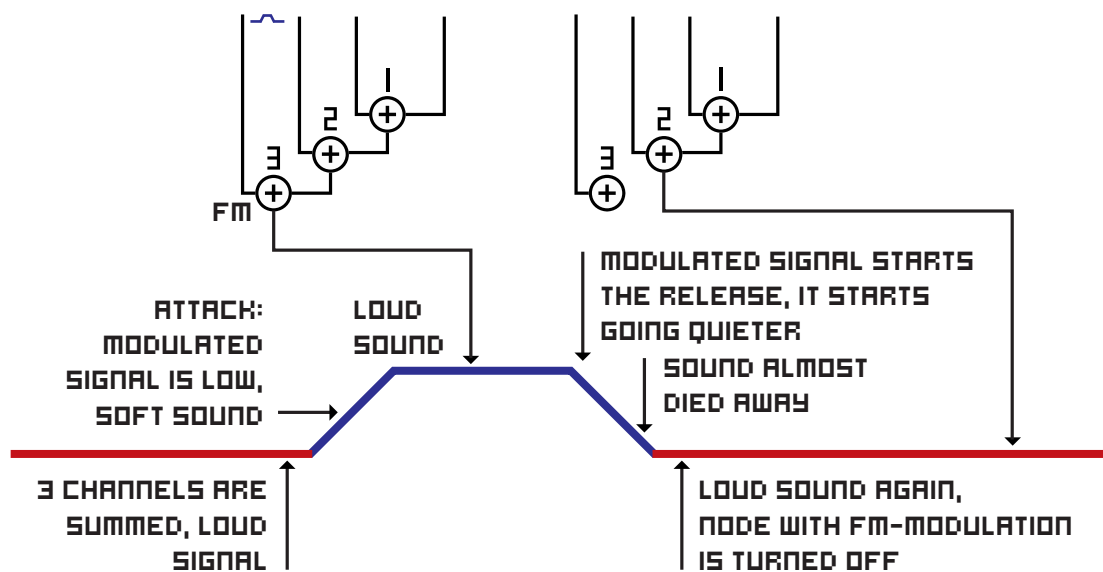

IT CAN BE USED AS A PART OF MUSICAL EXPRESSION. HOWEVER, IF YOU WANT A SMOOTHER SOUND, SWITCH TO THE SECOND MODE, WITHOUT BYPASSING THE SUMMING AMPLIFIER.



When the sequencer is playing notes, this mode can add more variety and flavor to the rhythm.

SEQUENCER

The synthesizer has a built-in sequencer that lets you record short looped sections. The length of the recorded section is one 4/4 bar (or 4 clicks of the metronome, or 4 LED signals from the clock). The sequencer is controlled with two buttons – "Record" and "Erase". To record, press and hold the Record button and play the rhythm on the pads. Further recorded parts will be layered on top of each other. To erase, press and hold the Erase button. To delete all data from the sequencer, hold Erase for the duration of the whole loop.



THE SEQUENCER ONLY WORKS WHEN THE LFOS ARE SYNCED, WHICH IS SET BY THE CLOCK REGISTER (1ST POT ON THE 7TH PAGE).

The sequencer can also be switched on and off. To do this, press Record and Erase at the same time. When the sequencer is off, the internal clock keeps running and when you bring the sequence back to life, it will continue from the same spot, where it would have been had it not been stopped. When the sequencer is off, the tempo LED quickly blinks twice in a bar.

SYNCING WITH OTHER DEVICES

Let's look at synchronizing the synthesizer with other devices. For example, let's take a portable Pocket Operator synthesizer. RoAT can function as both master and slave. Let's look at syncing it as master.

First, connect the devices. Connect the sync-out of the Rumble to the sync-in of the PO. Connect the audio outputs to a mixer.

Now, set up the devices.

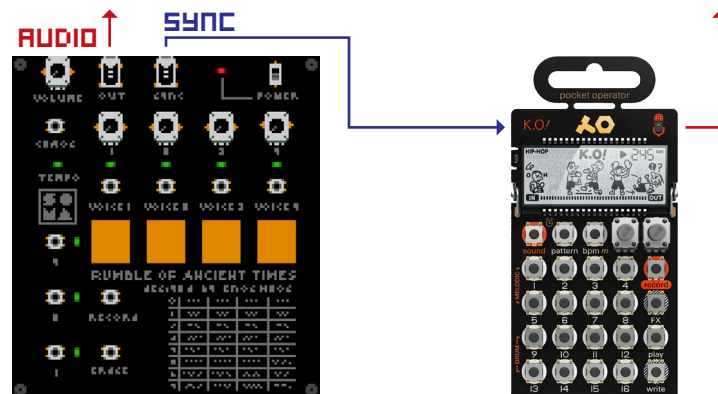

IN ROAT, GO TO THE LAST PAGE. SET UP THE TEMPO BY TURNING THE FIRST POTENTIOMETER. THE LED OF THE CLOCK SHOULD BLINK.

In PO, we need Sync Mode 2. Press and hold Func and BPM at the same time until you see 'SY2' on the screen. That's it. Press Play and the Pocket Operator will play in the same tempo as Rumble of the Ancient Times. The length of the recording loop equals the pattern length of the Pocket Operator, which equals 8 sync clock pulses.

You can also connect the synths without an external mixer. Connect the output of RoAT to the right input channel in PO, then connect the sync-out to the left channel and set up Sync Mode to 4.

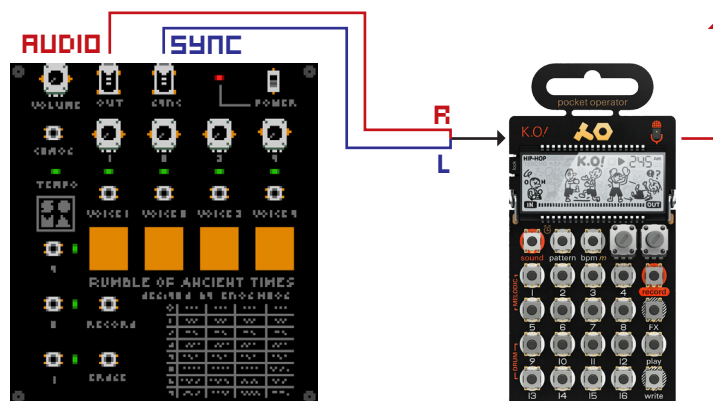

With this setup, the output of the Operator will include both the signal of the Rumble and the signal of the PO itself.

Now let's look at syncing as slave. Connect the left output of the Pocket Operator (sync-out) to Rumble and the right output to the mixer.

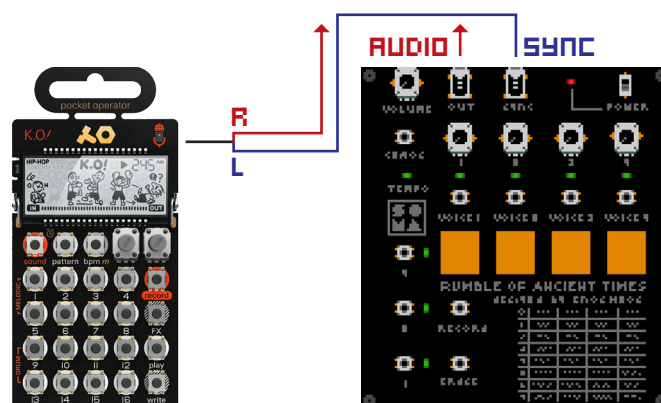

TO SET UP ROAT, GO TO THE LAST PAGE AND TURN THE FIRST POTENTIOMETER ALL THE WAY TO THE RIGHT, THUS TURNING THE DEVICE INTO SLAVE MODE.

Next, set up Sync Mode 1 in Pocket Operator. Now, when you press Play, Rumble will play synced to the PO. You can change the tempo and the sequencers and tempo will stay synced.

SPECIFICATIONS

Sync out voltage	5 V
Minimum syn in voltage	0.2 V
Current input	20 mA
Maximum output voltage	5 V
Audio output	3.5 mm jack
Sync out	3.5 mm jack
Power Supply	4*AAA batteries
Size	122 x 136 x 40 mm
Weight (without batteries)	145 g

RUMBLE OF ANCIENT TIMES TEAM:

Alexandr Zavgorodny aka Kakos_nonos – idea, firmware, visual effects.
Ilarion Zavgorodny aka John Norton Irr – pixel art.
Andrzey Slowik – production management and control.
Arsenii Vasylenko – translation and web administration.
Valeriy Zaveryaev – manual design and layout.
Vlad Kreymer – industrial design of construction and circuitry.
Grigory Ryazanov – creation of drawings for the mass production version.
Grzegorz Lacek – management, sales, and communications
Evgeny Aleynik – legal consulting.
Nastya Azartsova – front panel design drawing.
Pawel Wieczorek – production technologies.
Regina Volkova – SOMA assistant and management.
Sofia Rubinstein – demo video and creative direction.
Thomas Lundberg – communications, utopian linguist

www.somasynths.com

Kakos Nonos SOMA lab • 2021 год

